

Guidelines and Recommended Practices for Fiber-Reinforced-Polymer (FRP) Architectural Products



Compliments of:

Architectural Fiberglass, Inc
8300 Bessemer Ave.
Cleveland, OH 44127

www.fiberglass-afi.com (216) 641-8300

Published by



Guidelines and Recommended Practices for **Fiber-Reinforced-Polymer (FRP)** **Architectural Products**

Published by
American Composites Manufacturers Association

© 2016 American Composites Manufacturers Association
3033 Wilson Boulevard, Suite 420
Arlington, VA 22201
Phone: 703-525-0511
Fax: 703-525-0743
www.acmanet.org

All rights reserved.
No part of this book may be reproduced or resold in any form
or by any means without permission from the publisher.

Printed in the United States

ACKNOWLEDGEMENTS

The Architectural Division is one of the many specialty industry committees of the Composites Growth Initiative of the American Composites Manufacturers Association (ACMA). The Architectural Division has prepared this reference book of industry guidelines to introduce architects and designers to the use of Fiber-Reinforced-Polymer (FRP) composites as a building material. The editors would like to thank the many members of the ACMA Architectural Division and other industry professionals who contributed much time and effort to this publication.

Architectural Guidelines and Specifications Committee Members

Bill Kreysler, *Kreysler & Associates, Inc.*, **Chairman**

Nicholas Dembsey, PhD, PE, FSFPE, *Worcester Polytechnic Institute*, **Co-Chairman**

Robert Steffen, PhD, PE, *Western Carolina University*, **Technical Chairman**

Belle Blanding, *Composites Consulting Group*

Andy Bridge, *Janicki Industries*

Stephen Browning, PE, *Strongwell*

Brian Czuchra, *Chromoflo Technologies Corp.*

Michael Dobronos, *Architectural Fiberglass, Inc.*

Steve Dobronos, *Architectural Fiberglass, Inc.*

Brad Doudican, PhD, PE, *Advantic, LLC*

Michael Gordon, *Gordon Composites, Inc.*

Trevor Gundberg, PE, *Vectorply Corporation*

David Herzog, *Interplastic Corporation*

Guy Kenny, *Glassline, Inc.*

Kevin R. Lambrych, *Ashland Performance Materials*

Serge Labesque, *Kreysler & Associates, Inc.*

Aram Mekjian, *Mektech Composites, Inc.*

Bob Moffit, *Ashland Performance Materials*

Richard Pauer, *Polynt Composites USA, Inc.*

Kevin Spoo, *Owens Corning*

Michael Stevens, *Ashland Performance Materials*

Gale Tedhams, *Owens Corning*

Amol Vaidya, PhD, *Owens Corning*

Special thanks are extended to the Architectural Division ACMA Staff Liaison,

John P. Busel, FACI, *American Composites Manufacturers Association*

Very special thanks are extended to the following industry professionals and students who provided contributions to these guidelines and in some cases oversight and guidance on parts of this publication:

Jordan Composites

Kurt Jordan

Martin/Martin, Inc.

Emily Guglielmo, SE, PE, CE

Brent Hanlon, PE

Western Carolina University

Chad Allen

Logan Gentry

Worcester Polytechnic Institute

Blake Cornachini

Matt Foley

Sean Gillis

Nicholas Houghton

Scott Knight

Tom Ritchey

David Scott

Joseph Weiler

ACMA Architectural Division Members

3A Composites/Baltek, Inc.	ITW Polymer Adhesives North America
Advanced Plastics, Inc.	Janicki Industries
Advantic, LLC	Kalwall Corporation
American Fiberglass	Kreysler & Associates, Inc.
AOC, LLC	Mektech Composites, Inc.
Architectural Fiberglass, Inc.	NexGen Composites
Armortex	Owens Corning
Ashland Performance Materials	Plas-Tech Limited
Best Bath Systems	Polynt Composites USA, Inc.
Cegep Saint-Jerome	ProSlide Technology, Inc.
Chromaflo Technologies, Corp.	Sika Corporation
Composite Panel Building Systems	Strongwell
Composite Reinforcement Solutions	Symmetix Composites Tooling
Composites Consulting Group	Tecton Products, LLC
Composites One, LLC	The Gill Corporation
CompositesWorld	The R.J. Marshall Company
Custom Composite Technologies, Inc.	Tricel Honeycomb Corporation
E.T. Techtonics, Inc.	University of Massachusetts - Lowell
FCC Commercial Furniture	University of Miami
Fibratore, S.A.	University of North Carolina at Charlotte
FRP Accessories USA, Inc.	Vectorply Corporation
Glassline, Inc.	Vixen Composites, LLC
Gordon Composites, Inc.	Western Carolina University
GRG Technologies, LLC	Wetzel Engineering, Inc.
InPro Corporation	Windsor Fiberglass, Inc.
Interplastic Corporation	Worcester Polytechnic Institute

PREFACE

We trust that readers will find the material contained in this manual helpful in explaining some of the various uses and specifications for FRP composites and the standard practices followed by industry manufacturers. Please note that the ultimate decisions regarding the use of any material on a particular job must be made by the professionals involved in the project. Architects, engineers, material manufacturers, product manufacturers, and contractors must carefully evaluate the unique requirements of a project and the specifications and limitations of the materials selected. This is a guideline document only and more detailed information, which in some cases may modify or contradict the contents of this guide, is available through the ACMA or its affiliated member companies.

DISCLAIMER

Although ACMA publishes various technical materials including these Guidelines and Recommended Practices (the “Guidelines”), the Association does not develop or set official standards for the composites industry. Accordingly, the information contained in ACMA’s technical publications should not be construed as standards of the Association. Information in the Guidelines should be regarded as merely recommendations or optional guidelines for consideration of users.

The information contained in the Guidelines is believed to be accurate at the time of publication. The accuracy of this information, however, is not warranted. Each company or person using or distributing any such Publication is responsible for ensuring its accuracy and applicability at the time and under the circumstances used or distributed. Professional guidance should be sought.

ACMA makes no warranty of any kind, express or implied, with respect to information in the Guidelines, including merchantability or fitness for a particular purpose. Persons using the Guidelines assume all risk and liability for any losses, damages, claims, or expenses resulting from such use. Any persons who utilize the Guidelines agree to indemnify, defend and hold harmless ACMA, its officers, agents, and employees from and against any and all claims, suits, losses, damages, or costs, including reasonable attorney’s fees arising from or by reason of the use of the Guidelines.

TABLE OF CONTENTS

List of Figures	xiii
List of Tables	xiv
CHAPTER 1 – Introduction	1
1.1 Scope	2
1.2 What are FRP Composites?	2
1.3 Why use FRP Composites?	2
1.4 Where are FRP Composites Used?	3
1.4.1 Market Transformation	3
1.4.2 Architectural and Building Applications	4
1.4.3 Restoration and Replication	4
CHAPTER 2 – Raw Materials and Fabrication	5
2.1 Raw Materials	6
2.2 Fabrication Processes	7
CHAPTER 3 – Characteristics of FRP Composites	8
3.1 General	9
3.2 Mechanical Properties of FRP Composites	9
3.2.1 Tensile and Flexural Strength	10
3.2.2 Shear Strength	11
3.2.3 Compressive Strength	11
3.2.4 Modulus of Elasticity	11
3.3 Physical Properties of FRP Composites	12
3.3.1 Fiber Volume Fraction	12
3.3.2 Density	12
3.3.3 Shrinkage	13
3.3.4 Coefficient of Thermal Expansion (CTE)	13
3.3.5 Thermal Conductivity	13
3.3.6 Bonding Properties	14
3.4 Fire and Temperature Properties	14
3.4.1 Fire Properties	14
3.4.2 Effect of Temperature	14
3.5 Interior Properties	15
3.5.1 Acoustical Properties	15
3.5.2 Electrical Properties	15

**Guidelines and Recommended Practices for
Fiber-Reinforced-Polymer (FRP) Architectural Products**

3.6	Appearance of FRP Composites	15
3.6.1	Surface Finishes	15
3.6.2	Texture and Color	16
3.6.3	Size and Shape	16
3.7	Serviceability, Durability, and Long-Term Effects	17
3.7.1	Creep	17
3.7.2	Fatigue	17
3.7.3	Moisture Absorption	17
3.7.4	Ultraviolet (UV) Exposure	17
3.7.5	Corrosion	18
3.8	Composites Sustainability	18
CHAPTER 4 – General Considerations		19
4.1	Project Coordination	20
4.2	CSI Guide Specifications	20
4.3	Contractual Responsibilities	20
4.4	FRP Manufacturer Responsibilities	20
4.5	FRP Manufacturer Qualifications	21
4.6	Design Responsibility	21
4.7	Repair	22
CHAPTER 5 – Design		23
5.1	General Design Considerations for FRP Composites	24
5.2	Design Criteria	25
5.3	International Building Code (IBC) Fire Requirements	25
5.3.1	Interior Finish and Trim	25
5.3.2	Light-Transmitting Materials	25
5.3.3	Exterior Architectural Uses	25
5.3.4	Fire Performance Characteristics	26
5.3.4.1	Screening for Fire Performance	26
5.4	Structural	27
5.4.1	Shear and Tension	27
5.4.2	Service Loads	27
5.4.3	Design Stresses	28
5.4.4	Deflections	28
5.4.5	Handling Loads	28

Guidelines and Recommended Practices for
Fiber-Reinforced-Polymer (FRP) Architectural Products

5.5	Connections	28
5.5.1	Provisions for Movement	29
5.5.2	Anchorage and Connections	29
5.5.3	Inserts and Embedment	29
5.5.4	Joints	29
5.6	Support Structure	30
5.6.1	Stiffeners	30
CHAPTER 6 – Tolerances		31
6.1	General	32
6.2	Appearance	32
6.3	Material Tolerances	32
6.4	Product Dimensional Tolerances – Fabrication Tolerances	32
6.5	Installation Tolerances	33
CHAPTER 7 – Quality Assurance		35
7.1	Quality Assurance Program	36
7.2	Listing and Labeling	36
7.3	Quality Control Procedures	36
7.4	Certified Composites Technician – CCT	37
CHAPTER 8 – Loading and Delivery		38
8.1	General	39
8.2	Handling	39
8.3	Transit and Lifting Equipment	40
8.4	Temporary Storage	40
CHAPTER 9 – Installation		41
9.1	Unloading and Part Inspection	42
9.2	Erection	42
9.3	Cleaning	42
9.4	Repair	42
9.5	Misalignment	43
9.6	Joint Sealant	43
9.7	Fastener Torque	43
GLOSSARY OF TERMS		44
REFERENCES		143

APPENDIXES

APPENDIX A	Characteristics of FRP Composites.	48
APPENDIX B	The History of FRP Composites	51
APPENDIX C	FRP Composites Architectural and Building Applications	55
APPENDIX D	FRP Composites Raw Materials	57
APPENDIX E	Fabrication Processes.	73
APPENDIX F	Test Methods	78
APPENDIX G	CSI Guide Specifications	80
APPENDIX H	Fire Decision Tree for Architects	90
APPENDIX I	Fire Decision Trees for Manufacturers.	99
APPENDIX J	Engineering Design Guide	115
APPENDIX K	Typical Connection Details	126
APPENDIX L	Design Example	133

LIST OF FIGURES

FIGURE 3.6-1	Textured surface containing sand/polyester resin	16
FIGURE 5.6-1	Stiffeners attached to backside of an E-glass FRP panel	30
FIGURE D.3-1	Preparation of a composite using catalyzed unsaturated polyester resin and chopped strand mat.	59
FIGURE D.4-1	Glass-fiber-woven roving ply, with fibers in two orthogonal directions [0/90] to the sheet direction	61
FIGURE D.4-2	Randomly oriented fibers shown in a roll of chopped strand mat	62
FIGURE D.4-3	Single-end roving for pultrusion.	62
FIGURE D.4-4	Carbon-fiber-woven roving ply, with fibers in two orthogonal directions, [0/90] to the sheet direction	63
FIGURE D.5-1	Balsa wood core material	65
FIGURE D.5-2	Comparison of core to I-Beam	66
FIGURE D.5-3	Honeycomb sandwich construction	66
FIGURE D.5-4	Laminated sandwich construction with balsa wood	67
FIGURE J.2-1	Symmetric cross-ply [0/90/0] laminate	117
FIGURE J.2-2	Balanced [+45/-45] laminate	117
FIGURE J.4-3	[0/90/0] Laminate subjected to a transverse load.	122
FIGURE J.9-1	Stiffeners placed within a flat FRP panel	123
FIGURE J.9-2	Stiffening ribs placed within a curved FRP structural member	124
FIGURE J.11-1	Commonly used bent threaded-rod connector	125
FIGURE J.11-2	Commonly used large-head fastener connector.	125
FIGURE K.1	Cornice connection cross section – Type A.	127
FIGURE K.2	Cornice connection cross section – Type B.	128
FIGURE K.3	Cornice connection cross section – Type C.	128
FIGURE K.4	Section view: FRP panels with steel frame support – Type 1	129
FIGURE K.5	Section view: FRP panels with steel frame support – Type 2	129
FIGURE K.6	Section view: FRP panels with steel support and window – Type 3	130
FIGURE K.7	Section view: Internal support FRP panels attached to concrete substrate.	130
FIGURE K.8	Section view: Internal support FRP panels attached to wood substrate	131
FIGURE K.9	Vertical section view: FRP attached to steel column	131
FIGURE K.10	Embedded nutplate connection.	132
FIGURE L.1	SFMOMA architectural rendering of FRP cladding.	134
FIGURE L.2	Partial elevation view denoting FRP panel location, East elevation	136
FIGURE L.3	Load path to aluminum supports	138
FIGURE L.4	Finite element analysis (FEA) screenshots	139
FIGURE L.5	Connection capacity testing – threaded steel rod to FRP laminate	140
FIGURE L.6	Connection capacity testing – aluminum rod to FRP laminate.	141
FIGURE L.7	Calculation of connection components	141
FIGURE L.8	FRP connection to aluminum backup	142

LIST OF TABLES

TABLE 2.1-1	Summary of Typical Resins Used in Architectural Products	6
TABLE 2.2-1	List of Composites Manufacturing Processes	7
TABLE 3.2-1	Comparison of Mechanical Properties of Conventional Materials and FRP Composites	10
TABLE 3.3-1	Comparison of FRP Constituents and Specific Gravity.	12
TABLE 6.4-1	Typical Product Fabrication Tolerances	33
TABLE 6.5-1	Typical Installation Tolerances	34
TABLE 6.5-2	Gap Tolerances between Joints for Panel Dimension	34
TABLE D.4-1	Glass Fiber Types (IS ISO-2078 – Table-1).	63
TABLE D.7-1	Fillers Most Frequently Used in FRP Architectural Projects.	69
TABLE F.1-1	List of Composites Test Methods.	79
TABLE J.3-1	Typical Properties of Various E-glass / General Purpose Orthophthalic Polyester Resin Laminates Considered for FRP Architectural Panels	119
TABLE J.3-2	Typical Properties of Standard Modulus Carbon/Epoxy Laminates	120
TABLE L.3-1	Wind loading criteria calculated per ASCE 7	137

CHAPTER 1

Introduction

CHAPTER 1 ■ Introduction**1.1 SCOPE**

The purpose of these industry Guidelines is to provide accurate information to architects, engineers, specifiers, and owners. This information assists in the planning, preparation of specifications, design, execution, and supervision of the manufacture and installation of Fiber-Reinforced-Polymer (FRP) composites architectural products.

The goal of these Guidelines is to provide an understanding of FRP products to further ensure high-quality parts and components as well as uniform procedures. Such procedures will facilitate coordination between the architectural community and the FRP manufacturer of the composites products used in new construction, rehabilitation, historical restoration, furnishing, and other unique applications in the construction environment.

An additional purpose of this guide is to assist the architect, engineer, specifier, and building code official in designing and evaluating non-load bearing FRP composite parts. It is by no means intended to be a comprehensive design guide and covers only the most fundamental combinations of fiber, resin, and assembly details. For more comprehensive analysis tools refer to the appendices or seek the advice of one of the many licensed engineers experienced in the design and engineering of composites products.

1.2 WHAT ARE FRP COMPOSITES?

Fiber Reinforced Polymers (FRP), also known as “composites” are materials composed of fiber reinforcements and a polymer resin. The reinforcements impart strength and stiffness, while the resin is an adhesive matrix that bonds the fibers. In the finished part, the resin matrix transfers applied loads to the reinforcing fibers and protects the fibers from environmental attack.

1.3 WHY USE FRP COMPOSITES?

FRP composites offer many advantages compared to traditional materials, including:

- High strength
- Light weight
- Corrosion resistance
- Durability
- Design flexibility
- Part consolidation
- Dimensional stability
- Low thermal conductivity
- Good fire retardant properties
- Reproducibility

FRP composites can also include additional engineered attributes such as light transmission, high dielectric strength, conductivity, and radar transparency.

For a more detailed description of these and other benefits, see:

[APPENDIX A: Characteristics of FRP Composites](#)

CHAPTER 1 ■ Introduction**1.4 WHERE ARE FRP COMPOSITES USED?**

FRP composites are used globally in products ranging from recreational equipment, such as fishing poles and boats, to components of new commercial aircraft, such as the Boeing 787 Dreamliner. Principal markets served by the composites industry include:

- Architectural and Construction
- Automotive and Transportation
- Aerospace
- Infrastructure
- Recreational and Marine

The use of FRP composites in architectural applications is extremely diverse and includes products for new construction, rehabilitation, historical restoration, furnishings, and decorative installations.

1.4.1 MARKET TRANSFORMATION

FRP composites have been in use since the late 1940s. Early uses focused on marine applications, and this segment quickly adopted the use of composites. The majority of new personal watercraft (speed boats, wave runners, and sail boats) are made from FRP composites due to the corrosion resistance, impact resistance, durability, and design flexibility that composites offer.

A similar transition occurred in the automotive industry. The introduction of the 1953 Corvette marked the first large-scale application of FRP in automotive fabrication. The automotive industry leveraged composites for design freedom, part consolidation, and reduced weight. Market transformation in the transportation segment continued with the conversion of heavy trucks to composites, which began in the late 1960s and progressed rapidly to the point where almost all new heavy trucks were produced using FRP composites to take advantage of the low weight, durability, and corrosion resistance that composites offer.

The 1970s saw the first significant use of composites in aerospace, comprising approximately 10% of the materials used in the Concorde. The use of composites continues to build, with more than 50% of Boeing's 787 Dreamliner containing FRP composite materials to reduce weight, improve fatigue performance, reduce maintenance costs, and improve sound damping capabilities.

In the industrial area, FRP composites dominate applications that experience corrosive conditions, such as scrubbers and underground storage tanks. The use of composites has also facilitated the growth of wind energy, with almost all turbines utilizing composites due to the need for high strength-to-weight ratios.

A historical review of composites in civil engineering applications for new build and remediation projects can be found in:

[APPENDIX B: The History of FRP Composites](#)

CHAPTER 1 ■ Introduction**1.4.2 ARCHITECTURAL AND BUILDING APPLICATIONS**

In the area of architectural and building & construction applications, the transformation from traditional materials to composites has progressed at very different rates, depending upon the specific application. Composites have found widespread use in tub, shower, and countertop applications since the 1970s because of the value of low transportation costs, low installation weight, durability, and design flexibility.

In the 1990s, the building industry began to see the transition of window lineals and door skins to FRP composites. These products utilized FRP composites to realize excellent insulation properties, low thermal expansion which reduces seal and seat issues, the elimination of rust, rot, and swelling, and improved durability.

Complex facades, curvilinear shapes, and other unique architectural features were manufactured with FRP composites to overcome traditional material limitations. As the architectural community becomes more familiar with the benefits and design flexibility offered by composites, significant growth is expected in the manufacture of these composites for construction. The use of composites in exterior siding and cladding applications will result in improved durability and decreased dead and seismic loads compared to traditional wood, concrete, masonry, or metallic materials.

1.4.3 RESTORATION AND REPLICATION

Since FRP composites can be readily molded into complex forms, they are often used to replicate traditional building ornaments conventionally made of cast iron, terracotta, sheet metal, carved stone, or wood. Because of its high strength-to-weight ratio, FRP materials often reduce or eliminate the need to add an additional support structure. Such a structure is often required of “in kind” replications designed to meet current building codes. Since FRP composites are formable into complex shapes using relatively inexpensive molds, the materials can capture extremely complex forms reliably without loss of detail while also producing products that withstand impact better than most alternatives. Low-cost molds can be taken directly off of existing ornaments in the field in some cases, or can be readily fabricated using skilled craftsmen or through the use of 3-D scanning and CNC milling. The United States Department of the Interior’s National Parks Service recognizes properly fabricated FRP as an acceptable “alternate material” when used to reproduce traditional materials which may be obsolete, too costly, or unacceptably intrusive when applied to the existing building.

FRP composites building and architectural products and features can be found in:

[APPENDIX C: FRP Composite Uses in Architectural and Building Applications](#)

CHAPTER 2

Raw Materials and Fabrication

CHAPTER 2 ■ Raw Materials and Fabrication

2.1 RAW MATERIALS

FRP composites are composed of fiber reinforcements and a resin matrix that bonds the fibers. Such composites can also include core materials, fillers, and other additives to provide unique performance attributes.

Many types of resins, reinforcements, core materials, and additives can be combined to design very specific properties within FRP products. For example, combinations of these constituent materials allow for a diverse range of cost, durability, and strength values, as well as other attributes such as resistance to fire.

Typical matrix resin chemistries include unsaturated polyester, vinyl ester, epoxy, phenolic, and polyurethane resins. Unsaturated polyester resins (UPR) are the most common of the resins utilized in FRP composites. Key attributes of each resin type are summarized in Table 2.1-1.

TABLE 2.1-1: Summary of Typical Resins Used in Architectural Products

Resin Type	Key Attributes
Unsaturated Polyester (UPR)	Low material cost, low molding cost, room temperature cure, good mechanical performance, and best cost vs. performance.
Modified Acrylic	Low molding costs, room temperature cure, good mechanical properties with high filler loading, low flame spread and smoke generation.
Epoxy Vinyl Ester (EVER)	Higher material cost vs. UPR, low molding cost (similar to UPR), excellent corrosion resistance, improved mechanical properties and heat resistance compared to UPR.
Epoxy	Higher material and molding cost than EVER, excellent overall mechanical properties, high toughness.
Phenolic	Similar cost to UPRs, lower mechanical properties vs. UPRs, excellent flame retardancy without additives, high heat and solvent resistance.
Polyurethane	Similar material cost as epoxy resins, similar molding cost compared to EVERs, excellent mechanical properties, high toughness, and high adhesion to reinforcements.
Polyethylene Terephthalate (PET)	A thermoplastic polymer with mechanical properties higher than Vinyl Esters' but slightly lower than epoxy's. Excellent impact resistance and toughness properties with excellent adhesion to reinforcements.

The strength characteristics and many mechanical properties of FRP composites are heavily dependent on the type, amount, and orientation of fiber reinforcement that is selected. There are many commercially available reinforcements including glass, carbon, aramid, and natural fibers. Glass fibers, either in continuous strand or fabric form, are the most common fiber material used in architectural composite components.

The introduction of a core material “sandwiched” between fiber-reinforced laminate skins can significantly increase stiffness and flexural strength while reducing warping and bowing of flat surfaces. Thermal conductivity, sound insulation, and fire resistance can also be improved by use of the proper core material. Commonly used sandwich core materials include urethane, PVC or PET foams, end grain balsa and ply wood, paper, plastic or aluminum honeycomb, and non-woven core mats.

CHAPTER 2 ■ Raw Materials and Fabrication

The cost and performance of composites can also be heavily influenced by the many filler materials and additives available on the market. Consultation with the FRP manufacturer or raw-material supplier may illuminate opportunities for the use of fillers and additives to achieve desired improvements; the past experience of the manufacturer or supplier will help identify any necessary formulation or processing changes required to achieve a quality product.

For a detailed look at the raw materials commonly used in FRP composites, refer to:

APPENDIX D: FRP Composites Raw Materials

2.2 FABRICATION PROCESSES

The design flexibility of composites is a frequently heralded benefit. Composites are used to create products that are large or small, straight or curved, translucent or opaque. They can be fabricated to simulate other materials or provide unique finishes. FRP composites can be produced as one-time custom pieces or manufactured in high volume. While much of the product performance is engineered through the selection and reinforcement of raw material as well as through the core placement, design flexibility is driven by the various fabrication processes that can be utilized. A comparison of common FRP composites manufacturing processes and their typical products is shown in Table 2.2-1.

TABLE 2.2-1: List of Composites Manufacturing Processes

Fabrication Process	Considerations	Types of Products
Casting	Design flexibility – shape and color Often non-structural parts Low-cost molds, appropriate for small-run parts	Sinks Tubs Counter tops
Lay-up / Spray-up	Good for small-run parts Complex designs possible	Tanks Building facades
Infusion / RTM	Consistent part Complex design possible Mid to high volume	Building facades Furniture
Continuous Panel	Continuous flat sheet High volume Limitations on physical design Options for surface treatment / color	Light panels Building cladding
Pultrusion	Continuous shape, linear parts High volume Moderate design flexibility	Hand rails Siding Window lineals Standard and custom structural shapes
Press Molding	Very high volume Very consistent part Complex shape possible	Appliance bodies Door surfaces

A comprehensive overview of the fabrication processes used to produce FRP composites is available in:

APPENDIX E: Fabrication Processes

CHAPTER 3

Characteristics of FRP Composites

CHAPTER 3 ■ Characteristics of FRP Composites**3.1 GENERAL**

Traditional manufacturing methods, such as hand lay up, produce FRP composites composed of individual layers, or laminas, stacked to form a laminate as shown in Figure J.2-1 of [APPENDIX J: Engineering Design Guide](#). The finished characteristics of FRP composites depend on the type and ratio of matrix and reinforcement, the orientation of the reinforcement relative to the loads, the presence and type of structural core, the inclusion of fillers and additives, the fabrication method utilized, the fabricator's expertise, and many other factors.

Mechanical properties, physical properties, and other characteristics of FRP composite materials are measured using standardized laboratory test methods. For an overview of tests that are commonly used, see:

[APPENDIX F: Test Methods](#)

3.2 MECHANICAL PROPERTIES OF FRP COMPOSITES

FRP composites are anisotropic materials, meaning that their properties vary as a function of direction. The mechanical properties are dependent on composite design parameters such as reinforcement orientation and volume, as well as the thickness and number of layers of reinforcement. This engineering versatility allows the designer to optimize performance based directly on the structural requirements.

The primary FRP-composite mechanical properties reviewed within an initial structural design include, but are not limited to, tensile strength, shear strength, compressive strength, and modulus of elasticity. For thin laminates under bending conditions, flexural strength and modulus are also examined.

As in all structural design, two limit-state conditions should be satisfied in pursuit of a safe and functional structure: strength and serviceability. Strength design assures that the factored loads imposed on the structure do not exceed the factored strength (or resistance) allowables of the individual members. Serviceability design seeks to ensure that the structure complies with durability and human comfort limits while remaining within the elastic regime, such as deformation, vibration, and crack-control limits.

A comparison of common mechanical properties of conventional materials and FRP composites is shown in Table 3.2-1.

CHAPTER 3 ■ Characteristics of FRP Composites

TABLE 3.2-1: Comparison of Mechanical Properties of Conventional Materials and FRP Composites

Property	Units	Wood ^A	Concrete ^B	Steel AISI A36 ^C	Aluminum 6061 T6 ^D	FRP Laminate Type 1 ^E	FRP Laminate Type 2 ^E
Tensile Strength	ksi (MPa)	1.65 (11.4)	0.29 – 0.87 ¹ (2.0–6.0)	58 (400)	42 (290)	8.0–15 (55–103)	15–23 (103–159)
Compressive Strength	ksi (MPa)	1.9 (13.1)	2.9–8.7 (20–60)	58 (400)	35 (241)	18–25 (124–172)	21–27 (145–186)
Tensile Modulus	Msi (GPa)	1.8 (12.4)	3.1–5.3 ² (21.2–36.7)	29 (200)	10 (68.9)	0.7–1.3 (4.8–9.0)	1.1–1.8 (7.6–12.4)
Longitudinal CTE	in/in-°F (10 ⁻⁶) (cm/cm-°C (10 ⁻⁶))	1.7–2.5 ⁷ (3.1–4.5)	3.5–6.5 ³ (6.3 – 11.7)	6.5 (11.7)	13.1 (23.6)	3.1–11 ⁴ (6.1–19)	3.1–11 ⁴ (6.1–19)
Density	lb/ft ³ (g/cm ³)	34.3 (0.55)	137–156 (2.19–2.50)	490 (784)	169 (2.71)	91.3 ⁵ (1.46)	93.5 ⁶ (1.50)

Notes:

- A. Allowable strength values, dry, parallel to grain, 2x member, select structural grade, southern yellow pine, *2015 National Design Specification (NDS)*, American Wood Council, 2015
- B. Ultimate compressive strength values, unreinforced normal strength concrete, Nawy, Edward, G., *Reinforced Concrete: A fundamental Approach*. Upper Saddle River, NJ: Prentice-Hall, 1996
- C. Ultimate strength values, ASTM A36 Steel, *Cold-Form Steel Design Manual*, American Iron and Steel Institute, 1997
- D. Ultimate strength values, T6061-T6 allow sheet, *Specifications for Aluminum Structures*, The Aluminum Association Incorporated, 1976
- E. See Appendix J, Table J.3-1; strength, modulus, and CTE properties calculated along longitudinal (0 degree) direction
1. Concrete tensile strength approximated as 10 % of compressive strength, Commentary, Section 10.2.5, American Concrete Institute (ACI) Committee 318, *Building Code Requirements for Structural Concrete (ACI 318-11) and Commentary*, American Concrete Institute, 2011, Farmington Hills, Michigan.
2. Concrete modulus of elasticity approximation based on compressive strength, Section 8.5, American Concrete Institute (ACI) Committee 318, *Building Code Requirements for Structural Concrete (ACI 318-11) and Commentary*, American Concrete Institute, 2011, Farmington Hills, Michigan.
3. Based on hardened, normal strength and weight concrete, Mitchell, L.J., “Thermal Properties”, pg. 202-210, (1966), American Society for Testing Materials, STP 169-A, *Significance of Tests and Properties of Concrete and Concrete Materials*, American Society for Testing Materials, Philadelphia, PA.
4. Longitudinal direction CTE prediction based on Schapery, R.A. “Thermal Expansion Coefficients of Composite Materials Based on Energy Principles”, *J. of Composite Materials*, Vol. 2, 1968, using E-glass CTE = 5.4E-6 in/in°C and orthophthalic polyester CTE of 30-100 E-6 in/in°C, E₁ glass =79 GPa, E_{resin} = 3.2 GPa, and rule of mixtures predicted laminate elastic modulus values, for a range of fiber volume from 20% to 60%.
5. Based on rule of mixtures, calculated from VectorLam software provided by Vectorply Corporation, www.vectorply.com, considering 34% chopped strand mat glass fiber weight content
6. Based on rule of mixtures, calculated from VectorLam software provided by Vectorply Corporation, www.vectorply.com, considering 34% and 55% chopped strand mat and 0/90 woven roving glass fiber weight content, respectively.
7. Longitudinal direction CTE prediction based on Glass, S.V., Zelinka, S.L., “Moisture Relations and Physical Properties of Wood, Chapter 4 of *Wood Handbook, Wood as an Engineering Material*, (2010), General Technical Report FPL-GTR-190, United States Department of Agriculture, pg. 4-14.

3.2.1 TENSILE AND FLEXURAL STRENGTH

Fiber type, volume, and orientation are major factors influencing tensile and flexural strength. Quasi-isotropic laminates will exhibit consistent mechanical performance when tested along different in-plane axes, while a non-isotropic laminates' strength will vary dramatically as a function of the direction of load. Directionally-dependent tensile strength properties can be estimated as a function of the relative volume of fiber to resin. Flexural strength is typically governed by fiber tensile and compressive properties and lamina stacking sequence.

CHAPTER 3 ■ Characteristics of FRP Composites

For an FRP laminate required to withstand flexural loads (loads perpendicular to the plane of the laminate), the design is often governed by deflection requirements. In the event that additional stiffness is required, a lightweight structural core material can be introduced to separate the laminate plies, similar to the web separating the flanges in a W-shape steel beam. This transformation to a sandwich-core composite provides a much stiffer response without excessive weight gain. The use of structural core materials may produce a damage-tolerant system when loaded perpendicular to the surface.

Tensile elongation at failure will vary with resin type but is typically one to two percent. The shear elongation of the core will depend on the material chosen and the quality of the bonded interfaces.

3.2.2 SHEAR STRENGTH

Shear stresses may be described as in plane, transverse to the plane (through thickness), or between individual laminas. Characterization of the shear resistance of a given lamina or laminate will vary greatly depending on the test method chosen. The designer should employ the test method most representative of the design load condition in evaluating strength and serviceability limits.

In-plane shear properties are controlled by fiber orientation and laminate stacking sequence. Transverse, or punching, shear strength is highly dependent on reinforcement type and volume. Interlaminar shear strength is primarily dependent on the matrix and matrix/fiber interface properties. Sandwich core laminates loaded in bending will impose a shear load on the core which will often be the deciding factor in the type and density of core chosen, and will also tend to govern the design of the bonded interface between core and laminate skins.

3.2.3 COMPRESSIVE STRENGTH

Composites loaded in compression may experience a number of failure modes, including fiber crushing, elastic micro-buckling, or kinking, shear splitting, and global elastic buckling. Governing failure modes for a given composite lamina or laminate under compressive loading are often evaluated experimentally for a given fiber and matrix combination and geometry.

In the absence of buckling, the in-plane or edgewise compressive strength can vary depending on laminate design factors such as reinforcement, matrix, fillers, stacking sequence of reinforcement layers, and quality of fabrication. Global (Euler) or local buckling will often control the compression capacity of a laminate, although sandwich-core laminates are often designed with sufficient panel stability to allow the compressive strength of the laminate skins to control strength and stiffness. This can be true when loaded either longitudinally or transversely.

In sandwich-core laminates, compression perpendicular to the surface should be taken into account when selecting fiber type and/or core density.

3.2.4 MODULUS OF ELASTICITY

The modulus of elasticity of glass-fiber reinforced FRP materials in building components is often nearly an order of magnitude lower than that of steel or aluminum. However, carbon-fiber-reinforced FRP materials can be designed to provide comparable stiffness properties in line with those of steel or aluminum, if required. Individual fiber modulus, fiber orientation within layers, fiber volume (as compared to resin), and relative layer thickness will affect modulus values and become critical considerations in material selection for deflection-driven designs.

CHAPTER 3 ■ Characteristics of FRP Composites

For designing composite sandwich-core panels subject to bending loads, designers often use thin lamina skins bonded to a suitable core material to increase section stiffness. The flexural stiffness of a lamina, laminate, or sandwich-core composite is influenced by many factors such as reinforcement type, reinforcement content, and resin modulus, inorganic filler content, and stacking sequence.

Composite lamina modulus may be estimated by examining the relationship between the fiber and resin, and their volume ratio. Typically:

- Choose a fiber and resin and characterize or identify the appropriate modulus values.
- Employ the rule of mixtures to define a lamina-level approximate modulus as a function of volume fraction.
- Use classical lamination theory to determine laminate design properties.

3.3 PHYSICAL PROPERTIES OF FRP COMPOSITES

3.3.1 FIBER VOLUME FRACTION

The ratio of fiber reinforcement to resin matrix material is typically described by the fiber volume fraction (V_f), which is the fraction (or percentage) of the fiber in the total laminate volume.

An alternative to V_f is fiber weight fraction or content, W_f . This specifies the weight percentage of reinforcement in a laminate. At constant laminate thickness and zero air voids, the W_f can be used to determine V_f if the reinforcement and resin densities are known.

The fiber volume fraction is an important parameter, required to properly engineer FRP products, as the designer seeks to employ the optimal quantity of fiber to achieve strength and stiffness requirements.

3.3.2 DENSITY

The density of FRP composites is calculated by the Rule of Mixtures (EUROCOMP, 2005). The specific gravity for some common FRP constituent materials is shown in Table 3.3-1:

TABLE 3.3-1: Comparison of FRP Constituents and Specific Gravity

Component	Specific Gravity
Thermoset Resins	1.10 – 1.40
Glass Fiber	2.45 – 2.62
Carbon Fiber	1.70 – 2.2
Typical Fillers	2.58 – 2.71
Structural and non-structural core materials	0.06 – 0.38
Syntactic core	0.4 – 1.0

CHAPTER 3 ■ Characteristics of FRP Composites

The typical density range for an FRP laminate is 85 to 125 lb/ft³ (1360 to 2002 kg/m³). The density of sandwich laminates can be considerably less depending on the thickness and density of the core chosen as well as the thickness of the laminate skins.

3.3.3 SHRINKAGE

Thermosetting resins shrink volumetrically upon curing as a function of resin chemistry, cure temperature profiles, material volume, and quantity of fillers. The dimensional changes caused by shrinkage are usually relatively small and can thus be accounted for in the design of the mold or tooling; however, care must be taken when designing mating parts. Shrinkage is typically most evident at corners or where the shape or thicknesses of the laminate varies abruptly. Improper consideration for shrinkage can result in cracked or warped parts that exceed allowable tolerances.

3.3.4 COEFFICIENT OF THERMAL EXPANSION (CTE)

As is common with most materials, FRP composites expand as temperatures increase. The coefficient of thermal expansion (CTE) of the laminate can be calculated based on an accurate knowledge of the fiber and resin material found within individual layers, as well as the stacking sequence and thickness of the laminas (Daniel and Ishai, Section 6.9). Unsymmetric stacking sequences can result in part warpage upon thermal expansion (Daniel and Ishai, Section 6.14). The resin content in a laminate influences the CTE, as does the direction of the fiber reinforcement. An FRP part design must account for differences between the CTE of the FRP composites and that of adjoining or attached materials to avoid distortion or differential movement between components.

Since ambient temperatures of architectural panels are well below the glass transition temperature of the FRP, the thermal expansion response is uniform and relatively easy to predict. A typical CTE value for a chopped strand glass laminate with approximately 30% glass content in an ester resin is 7.2×10^{-6} in/in °F (13×10^{-6} in/in °C). This value will decrease with higher glass fiber content.

The CTE value will differ substantially for highly unidirectional laminates. For example, the CTE along the fiber direction in E-Glass/epoxy composites will be 3 to 4 times less than the CTE in the transverse direction of the fiber reinforcement (Soden, Hinton, Kaddour, 1998). The CTE for carbon-FRP composites differ substantially and may actually become zero or negative along the fiber direction.

3.3.5 THERMAL CONDUCTIVITY

The typical range of thermal conductivity for an E-glass-reinforced FRP laminate is from 2 to 5 Btu inch/ft² hour °F; in SI units the thermal conductivity is expressed as 0.3 to 0.7 Watts/m °K (Hancox, Mayer, 1994).

CHAPTER 3 ■ Characteristics of FRP Composites**3.3.6 BONDING PROPERTIES**

Successful bonding requires intimate knowledge of the adherend surface chemistry, adhesive application methods, surface preparation techniques, curing conditions, lifecycle load, and environmental exposure considerations.

The bond strength between two adherends, including FRP to metal, wood, or another material, is considered when an FRP designer determines the expected strength and stiffness values and the appropriate and representative test method(s) to confirm such values. Text methods ideally capture loading, environmental conditions, and the construction installation method. The ASTM D3164 Lap Shear Test has been used successfully for many construction applications; however, numerous other standard and non-standard methods have been employed successfully when necessary.

3.4 FIRE AND TEMPERATURE PROPERTIES**3.4.1 FIRE PROPERTIES**

The glass fiber reinforcement material within FRP composites has minimal flammability. Its use should be maximized in balance with the other performance requirements of the composites. Increases in glass fiber volume will generally improve the fire performance of FRP systems, with volume fractions typically ranging from 30% to 70% depending on the resin and additive characteristics as well as the fabrication process used. The use of FRP veils with fire retardant additives can also greatly improve the fire performance of FRP systems.

More detailed information related to design for fire performance is covered in Chapter 5 – Design, and Appendix H and I.

3.4.2 EFFECT OF TEMPERATURE

The thermal performance of FRP composites is largely determined by the polymer matrix, fillers, fiber type, and curing process. In general, isophthalic unsaturated polyester, most epoxy and epoxy-based vinyl ester, and most phenolic-based composites have excellent thermal performance for typical interior and exterior exposure. A characteristic concerning the use of FRP composites is a gradual increase in modulus, or stiffness, in lower temperatures, as compared to higher temperatures. In increased temperatures, a gradual decrease in modulus is notable when the resin matrix polymer reaches a point where it transitions from a glassy to a rubbery state. This transition is called the glass transition temperature, or T_g (ASTM D7028 DMA T_g). When the working temperature of an FRP composite approaches or is above the T_g, mechanical properties (in general) will decrease significantly. Typically, FRP composites are not used in structural or load-bearing applications if the composite part will see extended exposure at or above the T_g of the resin matrix. However, it is not uncommon to see FRP composites used in non-structural electrical or anti-corrosion applications, where temperature-related mechanical properties are minimally impacted by spikes in temperatures at or exceeding T_g.

Two other thermal properties should be considered: the HDT (Heat Distortion Temperature, ASTM D648) and the CTE (ASTM E289) as discussed in section 3.3.4. The HDT of FRP composites is often reported in excess of 500°F / 260°C, and is mainly influenced by the fiber type and content (%). The CTE can be of concern in carbon-fiber composites. In such laminates the low CTE along the fiber direction may result in expansion or shrinkage values considerably different than those of the surrounding or attached materials.

CHAPTER 3 ■ Characteristics of FRP Composites**3.5 INTERIOR PROPERTIES****3.5.1 ACOUSTICAL PROPERTIES**

As a combination of both low-modulus matrix and high-modulus reinforcement materials, FRP composites provide very good damping and attenuation of low- to mid-frequency sound waves. High-frequency sound waves are more likely to be reflected than absorbed. Properly designed FRP sandwich panels can be engineered to reflect a wide range of frequencies, exhibiting properties equal to those of higher density materials of greater mass. Sandwich-core laminates in particular can have excellent acoustic properties, with those properties being further influenced by the type, thickness, and density of the core chosen. These same cores will also provide excellent thermal insulation properties.

3.5.2 ELECTRICAL PROPERTIES

Glass-fiber reinforced polymer (GFRP) composites are an excellent electrical insulator having desirable dielectric strength and low loss factor. Additionally, GFRP composites are transparent to most electromagnetic fields. Properly designed sandwich-core laminates can also provide excellent transparency along with reduced weight and improved mechanical performance. Electromagnetic Interference (EMI) shielding and signal reflectance can be provided by incorporating metallic fillers or fibers into the laminate.

3.6 APPEARANCE OF FRP COMPOSITES**3.6.1 SURFACE FINISHES**

FRP composites can accept a wide range of surface finishes. A common surface finish for FRP composites is gelcoat, a specifically formulated polyester resin that is applied to the mold surface prior to laminate build-up. A wide range of colors, including clear and metallic, is available. Recent advances in ultraviolet (UV) stability technology have enabled resistance to photochemical degradation which allows properly applied gelcoats to produce years of quality service without significant changes in color. Since these are sometimes organic pigments, certain colors react differently than others under specific climates and exposures. Clear finishes and very dark colors represent the greatest challenges. Clear gelcoats rely to a great degree on chemical UV stabilizers, which deteriorate over time and ultimately allow UV radiation to affect laminates. Additionally, dark colors absorb heat and can result in surface distortion or reduced physical properties in extreme conditions.

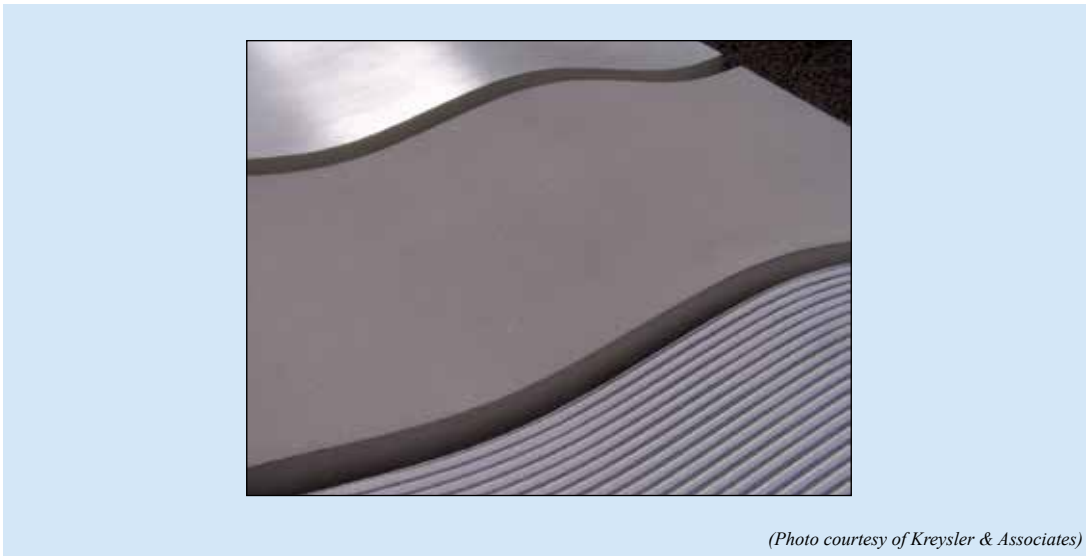
CHAPTER 3 ■ Characteristics of FRP Composites**FIGURE 3.6-1: Textured surface containing sand/polyester resin**

Other acceptable finishes are obtained with polymer concrete, applied in a method similar to gelcoating. Polymer concrete is often sandblasted to expose the aggregate. The thickness of a polymer concrete layer may vary, but attention should be paid to differential physical properties and cure shrinkage.

Painting systems are available for FRP composites finishes and are widely used in both the architectural and marine fields. The non-absorbent, inert nature of FRP composites allow for the application of surface paints. The paints need not be breathable and no extraordinary surface preparation is required beyond proper abrasion and removal of residual mold release agents. Ceramic tile, metal, wood, and other plastics can be adhered to FRP surfaces, provided differential thermal properties and panel deflections are allowed for in either the elasticity of the adhesive or mechanical attachment.

3.6.2 TEXTURE AND COLOR

A wide variety of textures and colors are available on multiple surfaces of FRP products. Textures including sandblasted surfaces with aggregates, flat, semi-gloss and glossy finishes are routinely provided. An example of a textured surface is shown in Figure 3.6-1. Since FRP composites are inert when cured, they can also accept a wide variety of coatings applied to the surface after curing. Different finishing techniques can have a significant impact on cost. Care should be taken to consult with a qualified manufacturer to ensure that the desired color or texture is achieved.

3.6.3 SIZE AND SHAPE

There is no technical limit to the size of an FRP composites part, although size may be limited by transportation and installation constraints. As with traditional materials, project-specific tolerances must be considered when designing FRP composites parts. Installation considerations should be discussed when selecting the optimum size of an FRP composites part.

CHAPTER 3 ■ Characteristics of FRP Composites**3.7 SERVICEABILITY, DURABILITY, AND LONG-TERM EFFECTS**

The durability of FRP composites products is widely considered superior to the durability of mild steel, aluminum alloys and stainless steels, or typical steel-reinforced concrete. FRP materials have been in widespread use since the late 1940's under a variety of conditions and in numerous applications. Due to the materials' inherent corrosion resistance, FRP products have found broad use in harsh environments such as chemical processing plants, coal-fired power plants, semiconductor facilities, and sewage treatment plants. Moreover, FRP designers have created innovative components and systems capable of withstanding temperature and/or moisture levels in extreme climatic regions, such as the tropics and Arctic poles.

3.7.1 CREEP

Thermoset composites are less susceptible to performance degradation as a result of long-term loads as compared to thermoplastic FRP materials. Large-scale structural applications such as pressure vessels and radomes demonstrate that FRP composites are capable of safely withstanding sustained loads over prolonged periods.

Creep studies of FRP composites indicate that these properties are controlled largely by the matrix material. Creep-related strains and deformations can occur in long-term, axial-loaded columns and beams at significantly high applied load levels (Zureick and Scott, 1998, Sa et.al 2011, respectively). The engineered FRP part should be designed such that working stresses should be sufficiently below ultimate stress levels. Some linear high-elongation cores will also demonstrate creep behavior. Thus if high continuous loading, specifically in compression, is envisioned, these types of cores should be avoided, or the density increased to suit the use.

3.7.2 FATIGUE

Properly designed FRP parts have excellent service lives under cyclic loading conditions as proven in automotive leaf springs, helicopter rotor blades, pressure vessels, boat hulls, and aircraft structures. Given tension-tension continuous cyclic loading conditions and similar to other building materials, FRP laminates will show a loss in the tensile modulus of elasticity as the cyclic load is increased relative to the ultimate tensile capacity of the uncycled control coupon (Wu et. al. 2010).

3.7.3 MOISTURE ABSORPTION

The moisture absorption found within E-glass reinforced polyester resin FRP materials is less than 2% for coupons immersed in water at 30°C (Hancox, N.L. Mayer, R.M., 1994). However, moisture absorption values in E-glass polyester or vinylester FRP parts are typically less than 1% for ambient environmental (temperature and moisture) conditions applicable to installed architectural panels and given recommended service-load-to- ultimate-load ratios and surface finishes.

3.7.4 ULTRAVIOLET (UV) EXPOSURE

Weathering of FRP composites is related to degradation of the polymeric portion of the matrix by ultraviolet (UV) exposure. In thermoset FRP composites, this attack is limited to the surface of the material and is typically contained within the surface veil material. As a result, this is only a cosmetic effect and does not typically affect the structural performance, as is evident in the marine industry. As with other building materials, the early stages of UV attack can cause color shift or yellowing and gloss

CHAPTER 3 ■ Characteristics of FRP Composites

changes. FRP composites should be protected from UV by an opaque gelcoat surface or by painting the exposed surfaces. Incorporating UV screens into the matrix is also useful. Of these techniques, gelcoating is the most common since it provides a desired surface finish and a deep 10-20-mil (0.25-0.51 mm) thick protective layer. Gelcoating is used by the marine industry to provide a durable long life finish on boat hulls. Properly prepared FRP composites can also accept a wide variety of other surface coatings, including oil- and water-based paint, as well as plural component systems such as urethanes. Factors influencing the weatherability of a gelcoated surface include the type of gelcoat resin, amount and type of fillers, and the colorants in the gelcoat.

3.7.5 CORROSION

Fiberglass reinforced composites are commonly used in architectural applications where other construction materials corrode or decay rapidly. FRP composite materials are frequently used in components that are exposed to aqueous chlorine solutions, from seawater to bleach and hydrochloric acid. The use of composite systems for the storage and transport of strong acids and bases is common. Composite laminates can also be used where resistance to corrosive gas is required throughout a wide range of temperatures, depending upon the FRP laminate composition. However, certain solvents are not suitable for contact with FRP components for extended periods of time. Because time of exposure, temperature, and chemical composition vary widely between applications, guidelines and case histories provided by resin suppliers and glass fiber manufacturers should be reviewed to determine the viability of employing FRP materials. Numerous American Society of Mechanical Engineers (ASME) and American Society for Testing Materials (ASTM) standards govern the design of tanks, piping, ducting, lining systems, and other structures used in corrosive environments.

3.8 COMPOSITES SUSTAINABILITY

FRP composites have inherent characteristics that make them a preferred material for innovative builders, architects, and product manufacturers. Such design professionals are often interested in producing products and buildings with a reduced ecological footprint. Increased durability, service life, and corrosion resistance are realized with FRP composites. In addition, they have a lower thermal conductivity, lighter transportation and installation weights, and a smaller carbon footprint, compared to most competitive materials.

FRP composites materials compare favorably to most conventional building materials in Life Cycle Assessment (LCA) studies. The energy needed to produce an FRP composite part using conventional manufacturing methods is often relatively low in comparison to the energy needed to produce conventional materials. Additionally, due to their high strength-to-weight ratio, FRPs often require less raw material. A typical square foot of FRP cladding, for example, weighs approximately 2 to 6 pounds, depending on back-up structure, wind loads, and finish. The same square foot in glass-fiber-reinforced concrete typically weighs 4 to 7 times more. Precast concrete cladding typically weighs 20 times more than similar FRP components. Aluminum, although comparable in weight, is more prone to corrosion and requires far more energy to produce. FRP's low weight characteristic translates into lower installation costs and a reduced back-up support structure, fewer individual parts, better thermal performance than most alternatives, and reduced energy use in installation equipment and procedures. FRP composites are increasingly used in applications where environmental efficiency and overall life-cycle costs are important.

[See APPENDIX J: Engineering Design Guide](#)

CHAPTER 4

General Considerations

CHAPTER 4 ■ General Considerations

4.1 PROJECT COORDINATION

Responsibility for the design, engineering, manufacturing, installation, and cleaning of the FRP product should be clearly defined.

4.2 CSI GUIDE SPECIFICATIONS

Construction Specifications Institute (CSI) guide specifications are an important tool for the architect, contractor, and manufacturer to use in specifying FRP composites architectural products. The *Composites Fabrications – Guide Specification for Fiber Reinforced Polymer Composites* was developed to assist in the correct specification of FRP composites products and their installation.

A more detailed description of a recommended guide specification is found in:

[APPENDIX G: CSI Guide Specifications](#)

4.3 CONTRACTUAL RESPONSIBILITIES

The areas of responsibility relative to FRP composite products that should be addressed in contract documents are:

- Architectural and Structural Design
- Engineering Specifications
- Shop Drawings
- Connections and Attachment
- FRP Component Manufacturing
- Shipping, Handling, and Storage
- Installation
- Maintenance
- Acceptance Criteria
- Quality Assurance Procedures

4.4 FRP MANUFACTURER RESPONSIBILITIES

The manufacturer is responsible for delivering clean, finished components that are in compliance with the construction documents. Once the installers accept the FRP parts from the carrier, they should assume responsibility for proper handling and protection of the components. Specialty items incorporated or attached to the FRP sections should be supplied to the manufacturer by the appropriate trade professionals along with detailed attachment, installation, and/or handling instructions. Specialty items must be properly engineered and authorized by the FRP manufacturer.

FRP architectural component production requires raw materials management, expert workmanship, product supervision, controlled curing cycles, and measurable quality control procedures. As is the case with other building materials, the use of FRP components requires advance planning and close coordination between the architect, engineer, manufacturer, erector, general contractor, and other members of the building team.

CHAPTER 4 ■ General Considerations

4.5 FRP MANUFACTURER QUALIFICATIONS

- *Corporate Management* – Company management should be experienced in FRP manufacturing, with knowledge of architectural product design, materials, process, and quality assurance.
- *Technical Support Personnel* – The Company should have technical personnel available either on staff or contracted from outside sources. These support personnel should include: designer, architectural draftsman, structural engineer, and field installation specialist.
- *Production Management* – The management team should be experienced in FRP production management and able to supervise the fabrication of FRP components. Personnel should understand production processes and materials as well as architectural drawings, design criteria, and quality assurance.
- *Workforce and Certification* – Employees should be adequately trained in the proper methods and techniques required of their job. At a minimum, the company should maintain a core group of experienced employees. The American Composites Manufacturers Association (ACMA) offers workforce certification with the Certified Composites Technician (CCT) program and recommends shop and field fabrication personnel obtain and maintain CCT certification.
- *Facility* – The physical plant must provide adequate floor space and conditions for timely production of quality products. The FRP manufacturer must possess the appropriate tools and equipment to perform the work and adequate housekeeping to ensure the required product quality. The manufacturing facility should be in compliance with applicable health, safety and environmental regulations and be available for customer and/or regulatory inspection.
- *Suppliers* – The Company should maintain a financial and technical relationship with raw material suppliers in order to facilitate material acquisition and problem resolution in an expeditious manner.

A Qualified FRP manufacturer should have:

- A written quality control/quality assurance program.
- A list of previous projects and references.
- Available technical literature and specifications.
- Current compliance to federal, state, and local regulations with necessary operating permits.
- In-plant housekeeping adequate to ensure quality products.
- Tools, equipment, and plant manufacturing space as required.
- ACMA –and CCT– certified personnel.

4.6 DESIGN RESPONSIBILITY

Design calculations should be performed under the supervision of a registered professional engineer with experience in FRP design, unless the part under consideration is agreed by all principals to be purely decorative, non-structural, and not subject to engineered performance. The FRP manufacturer should be prepared to assist in the design of panels, component assemblies, and connections. The project designer (architect/engineer) maintains overall project design responsibility, while the composites manufacturer is responsible for the FRP composites product design, manufacturing, and delivery.

CHAPTER 4 ■ General Considerations

The architect/engineer inexperienced in FRP design will benefit from early contact with experienced fabricators who can offer constructive advice during the preliminary design.

It is common practice for the architect/engineer to request from the FRP fabricator handling and erection procedures, as well as assurance that the unit is adequately designed for loads incurred during manufacturing, handling, shipping, and installation. All procedures should be checked to ensure they do not cause: (1) detrimental appearance, (2) structural damage, (3) architectural impairment, or (4) permanent distortion.

Drawings prepared by the architect/engineer should show connections in sufficient detail to permit design, estimating, and bidding. FRP fabricators, during the preparation of shop drawings, should show connections for tolerances, clearance, practicality, and performance. The molder/fabricator should indicate the fabricator's means and methods of achieving the design intent and should call potential fabrication problems to the architect/engineer's attention.

The fabricator and installer of any structural support frame or miscellaneous structural component should assume responsibility for locating bearing surfaces and anchorages on the structural frame in an effort to meet the requirements of the FRP fabricator's approved shop drawings. Changes, other than adjustments within the prescribed tolerances, should require approval by the architect/engineer as well as the FRP fabricator.

4.7 REPAIR

Most FRP composite products can be successfully refinished and repaired in the field by qualified personnel. The repair procedure will vary according to the level of damage. In general, repairs can be characterized as cosmetic or structural.

Cosmetic repair refers to damage to the coating or exterior finish of the FRP part. Such repair is often made with the FRP manufacturer's applied touch-up or surface-repair kit. The FRP manufacturer should be consulted to determine the appropriate materials, method of application, and curing procedure prior to any repair being made. Cure time, temperature, and humidity should be considered in the development of the repair procedure.

The FRP manufacturer and the engineer of record should be consulted prior to any structural repair to ensure structural integrity, compatibility between materials, and adequate quality assurance procedures. A repair can be considered a structural repair when the continuous fiber reinforcements have been broken or severed causing a gap or crack in the surface that extends partially or wholly through the thickness of the part. The width, depth, and length of crack should be measured to develop the correct repair procedure to sufficiently repair the damage. The repair procedure should include surface preparation procedures and note the specific repair materials required to restore part integrity. Cure time, temperature, and humidity should be considered in the development of the repair procedure.

Individual steps common to the repair of E-glass/vinylester or polyester resin systems are well documented (CCP 2005 Part 4, Chapter VII, RTP-1, 2013, Appendix M). The repair, however, should follow the FRP manufacturer's recommended procedure and use the repair materials supplied or specified by the manufacturer.

CHAPTER 5

Design

5.1 GENERAL FRP COMPOSITES DESIGN CONSIDERATIONS

The design of FRP composite components, parts, members, and assemblies is based upon industry understood procedures such as Allowable Stress Design (ASD) and/or Load Resistance Factor Design (LRFD). Similar to the design of wood members, an understanding of the strength and stiffness of the laminate in multiple directions is necessary.

Fiber-reinforced polymeric composite parts are often manufactured by stacking individual layers, or laminas, to create the total laminate. As a result, the applied stresses and strains within each layer and between layers are determined and are most often compared to allowable design values (ASD design) with a pre-determined factor of safety. Similarly the stiffness and strength of the total laminate is determined and compared to known allowables or strengths, often found from experimental testing and/or analytical approximation procedures such as finite element analysis (FEA) or lamination theory. All analytical procedures rely on known fiber and resin mechanical properties. [See APPENDIX J: Engineering Design Guide](#) for more information.

The high tensile strength achievable with FRP composites, along with a relatively low modulus of elasticity, allows for options not found in other construction materials used for similar purposes. FRP composites have a wide range of physical properties based on various available fillers, resins, fiber properties, and fiber orientation. Because of this, material specifications are often impractical as compared to performance specifications. Physical properties relating to strength and stiffness should be determined through test data provided by the manufacturer; they will be influenced by nonstructural design criteria such as fire resistance and architectural finishing. In special conditions where the product will be submerged, careful attention should be given to the selection of gelcoats, laminates, and manufacturing procedures.

Recognition of the various FRP-composite panel forms should be considered when evaluating structural performance. Common FRP panel construction typically employs either single-skin or sandwich-core construction.

With a single-skin laminate, the FRP design may incorporate a supporting framework, integral stiffening ribs, or bulkheads. In other cases the panel can be bolted or laminated directly to the structure. Often flexible anchors transfer skin loads to an intermediate steel frame. Another single-skin technique is to transfer skin loads to the structure through bulkheads or stiffening ribs embedded within the FRP laminate itself. With single skin laminates, care should be taken to ensure that sufficient anchor points resist deflection while allowing adequate flexibility for volumetric changes between the skin and the stiffening system resulting from thermal variations. Single-skin laminates are typically employed in conditions where the composite part geometry develops stiffness, and sandwich-core construction is unnecessary, impractical, or complicated.

Sandwich-core panels consist of an outer skin of FRP laminate, a lightweight core, and an inner skin of FRP laminate, such as that shown in Figure D.5-3 ([See APPENDIX D: FRP Composites Raw Materials](#)). In an FRP composite sandwich-core panel, the facing laminates act similarly to the flanges on an I-beam, providing the primary strength and stiffness of the panel in bending under transverse loads. The core carries most of the shear loading and stabilizes the thin facings against local buckling. Such sandwich-core panels have attractive strength, stiffness, insulating values, and weathering resistance.

Designs must comply with governing building codes and other applicable standards. Engineering design considerations such as, but not limited to, inter- and intra-laminar strains and stresses, applied loads, load combinations, safety factors, connection details and performance including bearing strengths and expected connection displacements, and member level strength and deflections, should be based on an engineering analysis performed by a registered engineer.

5.2 DESIGN CRITERIA

The following criteria should be used to calculate the design parameters and properties of FRP components with load combinations as outlined in the International Building Code (IBC) 2009 or 2012 editions:

Load Calculations

- a. Dead Load – Include the weight of every relevant component and attachment.
- b. Live Load – As specified by the local building code or authority having jurisdiction.
- c. Wind Load – As specified by the local building code or authority having jurisdiction.
- d. Seismic Load – As specified by the local building code or authority having jurisdiction.
- e. Temperature Load – As specified by the local building code or authority having jurisdiction.
- f. Other applicable loads described in the governing code.

Load Distribution

- a. Forces will be in reference to gravity load.
- b. Seismic forces will be considered oriented in the horizontal directions.

Load Combinations

- a. All applicable load combinations as outlined in the International Building Code (IBC) will be considered.
- b. Wind load and seismic loads need not be combined.

5.3 INTERNATIONAL BUILDING CODE (IBC) FIRE REQUIREMENTS

Use of FRP composites in architectural applications is governed by the International Building Code (IBC) 2009, 2012 or 2015 editions. The IBC covers three types of architectural FRP applications in Section 2612 (2009 and 2012 Editions) or Section 2613 (2015 Edition): interior finish and trim, light-transmitting materials, and exterior use.

5.3.1 INTERIOR FINISH AND TRIM

The IBC requirements for FRP composites systems for interior finish and trim are consistent with those of any approved material similarly employed.

5.3.2 LIGHT-TRANSMITTING MATERIALS

The IBC requirements for FRP composites systems for light-transmitting materials are consistent with those of any approved material similarly employed.

5.3.3 EXTERIOR ARCHITECTURAL USES

For exterior use, if the FRP assembly is to cover greater than 20% of the planar area of a building side and the building is 40 ft (12.2 m) or greater in height, then the FRP composites must meet requirements consistent with those of any approved material assembly. This includes structural and fire-performance requirements, among others.

If the planar area of the FRP composites on a given side of a building is less than 20%, then requirements specific to FRP are given in the IBC. If the building height is less than 40 ft (12.2 m), then different requirements specific to FRP are given in the IBC.

CHAPTER 5 ■ Design

A detailed representation of the fire requirements of FRP architectural panels for exterior use, are described in this Guideline for two perspectives;

[APPENDIX H: Fire Decision Tree for Architects](#)

[APPENDIX I: Fire Decision Tree for Manufacturers](#)

It is important to note that regardless of the IBC code, for any given project, the authority having jurisdiction has the final decision on the local interpretation of the applicable IBC requirements. It is recommended that the designer and fabricator be in contact with all the necessary stakeholders during the project to minimize errors in communicating local requirements.

5.3.4 FIRE-PERFORMANCE CHARACTERISTICS

For exterior or interior architectural surfaces, it is recommended that the fabricator design FRP-composites systems to achieve a minimum performance level for interior and exterior applications consistent with a Class A rating per IBC Section 803.1 and tested per:

- ASTM E84 (Tunnel Test) Flame Spread Index < 25
- ASTM E84 (Tunnel Test) Smoke Developed Index < 450

If the FRP-composites system meets these levels, it will satisfy many of the IBC requirements for an FRP component. When FRP systems are to be used on the exterior of a building, on more than 20% of the planar area of the building side, and the building is over 40 ft (12.2 m) in height, the exterior assembly that the FRP is part of has to demonstrate acceptable performance based on full-scale testing.

The organic portion of the FRP matrix is a hydrocarbon, which under the proper conditions will thermally decompose and support gas phase combustion. Several techniques are available to improve the flammability characteristics of FRP. The most common technique is to incorporate a halogen and synergist into the matrix. During combustion, the halogen and synergist interrupt the gas phase combustion process. Another technique involves the incorporation of hydrated fillers into the matrix. On heating, these fillers give up their water, acting as a heat sink to cool the FRP and reduce thermal decomposition. Another technique is to use a “char”-forming and/or intumescent additive that upon heating creates a blockage layer that insulates the FRP, thereby reducing thermal decomposition. Use of more thermally stable resins can greatly improve the fire performance of FRP materials especially in combination with the additives noted above.

5.3.4.1 SCREENING FOR FIRE PERFORMANCE

Efficient development of suitable FRP systems to meet the requirements of the International Building Code (IBC) can be accomplished using a screening process. This screening process allows the fabricator to understand the performance of a given FRP system and its potential to meet the testing requirements of the IBC for a given application. The screening process uses the Cone Calorimeter (ASTM E1354). The Cone is a bench scale apparatus that exposes 4-inch-by-4-inch (100-mm-by-100-mm) panels to a uniform thermal insult (incident heat flux). The incident heat flux of the Cone can be selected to match the thermal insult of any of the test methods required by the IBC. Many commercial laboratories have Cone apparatuses and can

CHAPTER 5 ■ Design

burn panels at a cost of a few hundred dollars per burn at the time of this publication. This is significantly less expensive than the cost of the full-scale tests required by the IBC. The key data from the Cone are the time to ignition, burn duration, heat release rate per unit area, and the smoke production rate. Given these data the commercial lab, fabricator and/or fire protection engineer can reliably estimate the performance of the FRP system in a given full-scale test required by the IBC. The Cone is not required by the IBC but is valuable as a development tool.

5.4 STRUCTURAL

The mechanical properties of primary interest for the structural design of an FRP laminate are given in [APPENDIX J: Engineering Design Guide](#), Tables J.3-1 and J.3-2. FRP composite panel systems can be analyzed by many engineering methods. Depending on the shape, panel stiffening system, and the intended use, a variety of choices exist to evaluate loads and structural performance. Often, due to the complexity of FRP panel shapes, the most representative method to predict actual field conditions is that of physical laboratory testing. Numerical methods such as finite element analysis (FEA) are valuable in the early design stage and beyond for laminates with or without stiffeners or laminates containing cores. This analysis should be performed by a professional engineer with experience in the intricacies of FRP composite numerical solutions and accurate modelling of connection details. Most experienced FRP material suppliers can greatly assist in the laminate design recommendation for a new project.

5.4.1 SHEAR AND TENSION

Interlaminar shear seldom controls the design of thin, flat FRP laminates. Efficient shear transfer can be achieved between layers and connections provided proper engineering designs and manufacturing techniques are employed.

Paraffin or other surface agents are currently used to reduce emission rates. Wax-type additives can affect interlaminar bonding in FRP materials. In such cases, panel design must allow for convenient abrasion (e.g., sanding) of laminate areas that are later to accept secondary bonds. The core in a sandwich laminate will attract shear loads induced by the load-bearing skins. This calculated shear load is considered when selecting an appropriate core material and thickness.

5.4.2 SERVICE LOADS

Because of the FRP composite panels' low self weight, dead load is often relatively small as compared to live loads, and the designer should pay particular attention to uplift loads induced by wind. Care should be given to local aerodynamic effects and the geometry of the structure and panel.

Important thermal considerations are the temperature gradient through the panel, the effects of thermal differentials due to panel geometry such as soffits and returns, and the differential properties of facing materials such as ceramic tile, veneers, or polymer concrete. These effects can be exacerbated in multi-material systems such as sandwich-core composites. Consideration should be given to surface temperatures exceeding the ambient temperature due to solar radiation. This is particularly important where surface colors are dark or the FRP is bonded to a dissimilar material. It is possible to exceed the heat distortion temperature of certain resins and core materials under extreme conditions, particularly if heat-absorbing surface colors are specified.

Consideration should also be given to the heat distortion temperature of the resin and the core since elevated temperature can affect the physical properties. FRP-composite panels should be designed for the horizontal and vertical contraction and expansion of component materials without excessive

CHAPTER 5 ■ Design

buckling, the opening of sealed joints, excessive stress within panel components and fasteners, and other detrimental effects.

Minimum design loads in the governing building codes, along with additional service loads and conditions stated in this recommended practice, should be included when assessing development of the design load combinations.

5.4.3 DESIGN STRESSES

In determining inter- and intra-laminar stresses, load combinations should be considered in order to establish the highest stresses and compare such stresses and calculated strains to appropriate failure criteria. The overall panel geometry and laminate stacking sequence should be considered when determining the effects of gravity loads, wind loads, earthquake loads (if applicable), and thermal expansion/contraction stresses.

5.4.4 DEFLECTIONS

FRP composite structural members should have adequate stiffness to limit deflections, elongations, or rotations below serviceability requirements. It is noted here that although flat FRP composite laminates can be designed to meet deflection requirements, connection- related deformations as well as part curvature should also be considered when estimating deflections.

Deflections due to service loads have been limited to $L/90$ of the span in previous FRP architectural panel installations. This is a fairly large allowable deflection when compared to the serviceability deflection limits of other materials. The engineer of record may choose to allow greater deflections in non-structural elements, provided such deflections are proven to not affect the overall design.

5.4.5 HANDLING LOADS

Loads due to transportation and handling can at times exceed the design service loads of the FRP components. Care must be taken to transport, store, and install FRP members in accordance with manufacturer's handling and erection instructions. Proper lift-points, approximate center of gravity, and dead-load magnitude should be identified both on the part and on the shop drawings. In addition, any special handling requirements must be clearly stated on shop drawings. Any deviation from the FRP composites manufacturer's instructions must be approved by the manufacturer in advance.

5.5 CONNECTIONS

FRP composite members have been installed typically with 1) traditional fasteners using screws or bolts, 2) bonded and bolted connections or, 3) bonding to substrates such as concrete, masonry, timber, or steel. The bearing strength of pinned or bolted connections is quite low compared to that of aluminum, steel, wood, or the tensile or compressive strength of the FRP material itself (Steffen, 1998). Dimensions between adjacent holes and free edges should be increased as compared to typical geometric ratios employed for steel or aluminum materials. Laminate design, including lamina materials and fiber orientation, will also affect bearing strength and failure modes, which subsequently affect the requisite bolt dimensions and configuration. Rigidity of the end conditions, such as that imposed by the introduction of an FRP gusset plate, can result in greater bending deformations and stresses in the connection and incident members (Steffen, 1998).

CHAPTER 5 ■ Design

Typical connection details used in FRP architectural applications are given in [See APPENDIX K: Typical Connection Details](#) for lightly loaded members. Connection details can also be designed for the higher loads commonly seen in heavy timber or aluminum connections.

5.5.1 PROVISION FOR MOVEMENT

The design and detailing of anchorages, connections, and joints must allow for differential dimensional changes of FRP components and the supporting primary structure due to thermal effects or differential deflection. Bolted connections in FRP components are expected to slip and/or relax over time if both members are FRP components containing traditional bolts, washers, and nuts. As such, designs typically rely on the bearing strength of the bolt holes rather than on a slip-critical or clamping effect. Information related to joints and tolerances should be indicated on shop drawings.

5.5.2 ANCHORAGES AND CONNECTIONS

The design of anchorages and connections should consider fit tolerances and eccentricities of load. Edge-to-hole center and end-to-hole center distances of inserts and embedments should be considered in the design and reflected in shop drawings and installation instructions as necessary. Edge-to-end distances of inserts and embedments should be provided.

5.5.3 INSERTS AND EMBEDMENTS

Corrosion-resistant inserts are desirable for use in FRP components. Inserts should be properly embedded in built-up bosses or bonding pads to achieve proper load distribution and prevent failure. The bosses should have a diameter of at least 8 times the embedment depth with the distance between the edge of the insert and the edge of the panel at least 3 times the bolt diameter. Larger bosses and edge distances may be required depending on the load and insert configuration, as well as fiber orientations.

Care is needed to encapsulate inserts. The insert area should be easily accessible during manufacture. The appropriate material must be used around the inserts, and resin-rich areas are to be avoided. Encapsulated inserts should protrude slightly above the surface of the FRP panel. Insert attachments should bear directly upon the insert, not the FRP surface, to prevent pullout of the insert when the bolt is tightened.

With adequate precautions, overstressing can be avoided. These precautions include isolation of embedded items, use of a bond breaker, discontinuity of a rigid item, or an increased section of material. Inserts in fire-rated composites panels must be able to withstand temperatures anticipated during the required fire-resistance period.

5.5.4 JOINTS

The design of the joints between FRP composites panels is an integral part of the total system design. Requirements for joints should be assessed with respect to both performance and cost. A joint width should not be chosen for reasons of appearance alone. Joints must relate to unit size, building tolerances, anticipated movement and story drift, joint materials, adjacent surfaces, and thermal movement.

Movement capability is expressed as a percentage of the joint width when installed. Joint widths should be 4 times the anticipated movement unless a low modulus sealant or no sealant is used, in which cases joint width may be as narrow as twice the anticipated movement.

CHAPTER 5 ■ Design

For example, if a joint is expected to move $\frac{1}{4}$ inch (6mm), for a given length of panel, the joint width should be at least one inch + $\frac{1}{4}$ inch / -0 inch (25 mm + $\frac{1}{4}$ mm/- 0 mm). The minimum design joint width may be $\frac{3}{4}$ inch +/- $\frac{1}{4}$ inch (19 +/- 6 mm) if a low modulus sealant or no sealant is used. Wider joints may be required for longer panel lengths. The minimum panel edge return for proper application of a joint sealant is 1 $\frac{1}{2}$ inches (38 mm), with 2 inches (51 mm) preferred.

5.6 SUPPORT STRUCTURE

Depending upon the design, FRP composites laminates may be attached directly to the support system with or without intermediate frames. Care must be taken to incorporate connections through the panel. In some cases, the use of embedded materials is required to help distribute localized loads into the laminate. These connections are typically designed by the FRP composites panel manufacturer or FRP design engineer. The panel or the panel frame is then attached to the building structural frame. Such a structural frame must allow for differential movement to avoid over-stressing panel-to-frame connection points. Panel loads are carried through the connection points to the structure. These locations are determined by the architect, structural engineer, and FRP composites manufacturer collectively during the design stage. The engineer and FRP composites manufacturer should evaluate the compatibility between the FRP materials and support structure.

5.6.1 STIFFENERS

Stiffeners may be categorized as prefabricated stiffeners that can be attached to the composite panels after panel fabrication or integral stiffeners that can be built into the geometry of the composite panels.

Prefabricated stiffeners may be FRP components or metal members that are placed on the composite panels where required for stability via bonded or fastened joints; or they may be embedded in the composite structure during panel fabrication. In some instances, panels may be strengthened by adding supplemental metal assemblies or frames.

Stiffeners may also be directly fabricated and integrated into the elements of the composite panel geometry during manufacturing as shown in Figure 5.6-1. These integral stiffeners may be single-skin ribs that are attached to flanges or may be embedded directly within the panels. Interior sections of individual stiffeners, which may be hollow or solid, are often comprised of endgrain balsa wood, shaped PVC or urethane foam, cardboard tubes, or thin pre-molded FRP shapes.



(Photo courtesy of Kreysler & Associates)

FIGURE 5.6-1: Stiffeners attached to backside of an E-glass FRP panel

CHAPTER 6

Tolerances

CHAPTER 6 ■ Tolerances**6.1 GENERAL**

Tolerance is a permissible variation from specified requirements shown within a project's set of shop drawings, architectural drawings, engineering drawings, or related specifications. Within a given project's contract documents, tolerances should be provided, as necessary, for dimensions, locations, and other critical features.

6.2 APPEARANCE

At the time the sample, mockup, or initial production units are approved, the acceptable variations of color, texture, and uniformity should be determined. It is beyond the scope of this document to establish definitive rules for acceptability. Acceptance criteria may be available in the project's contract documents. In general, the finished FRP surface should present a pleasing appearance with minimal color and texture variations from the approved sample when viewed in typical lighting from a 10 ft (3 m) distance. No other obvious imperfections such as chips, cracks, or foreign matter should be visible at a 20 ft (6 m) viewing distance.

6.3 MATERIAL TOLERANCES

In-process and post-process quality assurance testing will verify compliance with the following specification tolerances:

- Raw material characteristics shall be within product specifications.
- Reinforcement content shall be $\pm 10\%$ of the specified fiber volume fraction.
- Laminate Barcol hardness shall not be below the specified minimum, generally 90% of the manufacturer's specification for a particular resin.
- Mechanical properties of the processed materials shall not be below the specified minimum.

6.4 PRODUCT DIMENSIONAL TOLERANCES – FABRICATION TOLERANCES

Part tolerances are normally established by economical and practical production considerations. Tight tolerance specifications will tend to increase the overall cost of the product. The individual skill of the craftsmen, including pattern makers, mold makers, and FRP laminators will determine the degree of accuracy of molded components, and thus the tolerance of the manufactured part.

The actual thickness of FRP products may deviate, within given tolerances, from the design thickness according to the method of manufacturing. The project contract and/or specifications should specify acceptable tolerance values. Common minimum and maximum thickness tolerances are often given as either 15% of the design value or the necessity to remain within 1/16 inch (1.5mm) of design. Maximum thickness values must be evaluated for overall variations in thickness versus design. A general maximum variation of 1/16 inch (1.5mm) can be applied, but increased tolerances should be allowed for change in plane, radius sections, stiffening ribs, etc. Typical fabrication tolerances are shown in Table 6.4-1.

CHAPTER 6 ■ Tolerances

TABLE 6.4-1: Typical Product Fabrication Tolerances

Type	Application	Tolerance	Comment
Length and Width	< 10 ft (3m)	$\pm 1/8$ inch (3mm)	Overall length and width of units measured at the face adjacent to the mold.
	10 ft – 20 ft (3-6m)	$\pm 3/16$ inch (5mm)	
Variation from Square	0 ft–10 ft (0-3m)	$\pm 1/4$ inch (6mm)	
	>10 ft	Length/1000	
Out of Plane	< 10 ft (3m)	$\pm 1/4$ inch (6mm)	
Warping or Bowing	< 10 ft ² (3m ²)	$\pm 1/4$ inch (6mm)	
Gelcoat Thickness	Outer surface	-.002 /+.010 (-.05 /+.254mm)	
Position of Integral Items	Mounting devices	$\pm 1/4$ inch (6mm)	
	Internal supports/stiffeners	$\pm 1/2$ inch (12mm)	
	Steel studs and tracks	$\pm 1/4$ inch (6mm)	
	Flashing reglets (panel edge)	$\pm 1/4$ inch (6mm)	
	Reglets for glazing gaskets	$\pm 1/8$ inch (3mm)	

6.5 INSTALLATION TOLERANCES

Cumulative errors from the primary structure, supporting structures, and FRP composites part can cause problems of fit in the field if dimensional tolerances are not properly assessed. Compatible tolerances of all adjacent components, which take into account the properties of the materials and the capabilities of the manufacturing and construction process, will produce the best results. Therefore, close collaboration between the manufacturer and other members of the building design team is essential for proper fit and placement of installed composites products.

Care should be taken to ensure that any stresses introduced during installation to accommodate alignment requirements do not exceed the allowable design stresses or compromise the ability of the component to withstand design loads. Maximum permissible warpage of one corner out of the plane of the other three should be 1/8 inch /ft. (5 mm/M). Gaps between adjacent members should be maintained in order to allow for free thermal expansion and contraction. Typical installation tolerances are shown in Table 6.5-1.

CHAPTER 6 ■ Tolerances

TABLE 6.5-1: Typical Installation Tolerances

Type	Tolerance	Comment
Warpage	$\pm 1/8$ inch (3mm) per foot (305mm) 3/8 inch (10mm) total	There is a maximum allowable warpage of each panel corner relative to other corners of the same panel.
Bowing	$< L/200$	
Maximum offset from true alignment	$\pm 1/4$ inch (6mm) in 20 ft. (6.1m)	
Maximum variation from true position	$\pm 1/2$ inch (13mm) in 20 ft (6.1m) of length	

All structural frames and building facades (steel concrete, wood, etc.) have an inherent erection tolerance described in the contract documents, building code, or other codes of standard construction practice. The design team should provide sufficient allowances in panel spacing to accommodate this tolerance plus the fabrication tolerances of the FRP panels. If clearances are realistically assessed, they will solve many installation tolerance problems.

Gap tolerances for integrally molded and field-cut joint flanges should be maintained at $\pm 1/16$ inch (1.5mm) relative to intended design width. The joint gap between installed panels need not exceed the values shown in Table 6.5-2.

TABLE 6.5-2: Gap Tolerances between Joints for Panel Dimension

Application	Tolerance
< 10 ft (3m)	3/16 inch (5mm)
10 ft–20 ft (3-6m)	$1/4$ inch (6mm)
> 20 ft (6m)	5/16 inch (9mm)

CHAPTER 7

Quality Assurance

CHAPTER 7 ■ Quality Assurance**7.1 QUALITY ASSURANCE PROGRAM**

The manufacturer should have an established, written Quality Control/Quality Assurance Program in effect at the fabrication facility. This QC/QA program must address raw material compliance, material storage, material acceptance, in-process procedures, verification of procedures and acceptance, and final product inspection. The QC/QA program must also comply with applicable codes and project specifications.

Prior to starting work, the composites manufacturer should submit written quality assurance procedures and product data sheets to the specifier. During production of the composites components, daily log sheets should be maintained that record the following information:

- Raw material batch numbers.
- Spray equipment settings and calibration.
- Serial numbers of items produced.
- Quality assurance inspection results.
- Environmental conditions.
- Other pertinent product and manufacturing information.

A record of part numbers produced under the above conditions should be maintained by the part fabricator and, if applicable, must be permanently affixed to each part prior to delivery.

7.2 LISTING AND LABELING

For projects that must conform to the International Building Code (IBC), Section 2612.2 requires “labeling and identification”. All FRP products delivered to the job site need to have a label from an approved agency. This label will allow the authority having jurisdiction to determine if the FRP complies with IBC requirements. The fabricator will need to establish a quality control and testing program with an agency approved by the International Code Council.

7.3 QUALITY CONTROL PROCEDURES

Quality control procedures may include, but are not limited to, the following applicable inspections and records:

A. In-process procedures:

1. Tests of raw materials to verify compliance to standards.
2. Raw material batch or lot numbers traceable to part numbers.
3. Serial number for each part.
4. Spray gun calibration – resin: glass / resin: catalyst.
5. Gelcoat thickness – applied wet film.
6. Length of chopped fiber and type of glass used.
7. Number and thickness of each chop fiber application and/or weight and number of plies of cloth/mat.

CHAPTER 7 ■ Quality Assurance

8. Cure and/or de-molding time.
9. Post-molding inspection.
10. Barcol hardness readings.
11. Part weight.
12. Record of in-plant re-work or repairs.

B. Finished-product inspections:

1. Product properties by ASTM industry standards.
2. Dimensions of each molded piece.
3. Confirm aesthetic characteristics match agreed upon standards.

7.4 CERTIFIED COMPOSITES TECHNICIAN – CCT

The American Composites Manufacturers Association (ACMA) provides a certification program – Certified Composites Technician (CCT) for FRP manufacturing plant personnel. The Construction Specifications Institute (CSI) guide specifications ([See APPENDIX G: CSI Guide Specifications](#)) for FRP composites products require that CCT-certified staff participate in the production of FRP architectural products. The designer or specifier should request copies of current certificates prior to beginning fabrication.

CHAPTER 8

Loading and Delivery

CHAPTER 8 ■ Loading and Delivery**8.1 GENERAL**

The FRP manufacturer should clearly mark or tag all FRP composite parts to coincide with project documents, including shop drawings. The techniques and procedures used for handling and preparing architectural FRP building products for shipping should be adequate to assure delivery of damage-free products. A process for inspection on arrival at the installation site should be described in the contract documents. Procedures and repair materials for minor touch-ups as well as major repairs should be specified in the contract documents or purchase order and shipped to the project jobsite, ideally with the FRP composite parts. Sharp edges which may injure personnel or cut lifting equipment, including straps, should be addressed with a chamfer or edge protection prior to shipment.

8.2 HANDLING

Impact, excessive distortion, premature handling, or unanticipated or excessive shipping loads can compromise the FRP composite part and its finish. Therefore attention should be paid to the following:

- A. The means of lifting and handling FRP products need to be assessed during the product design phase. At times, lifting points, harnesses, or other means need to be engineered and installed in the composite parts to ensure their safe handling.
- B. Manufacturer's shop drawings should include recommended handling procedures as well as the center of gravity for large components and/or non-typical geometries.
- C. Care should be taken to ensure that the finish of the shipped FRP part is not damaged or blemished due to wrapping or handling prior to adequate finish curing.
- D. FRP components should be lifted and not dragged, rolled, dropped, or thrown.
- E. Open-end parts such as cylinders and partially-hollow objects may require internal or external bracing during handling and installation to prevent damage in transit.
- F. When lifting uncrated FRP parts in a vertical position or when lifting at lift points that do not coincide with the connection, a spreader bar should be considered to prevent damage from excessive distortion. If a spreader bar or other procedure for relieving local stress is required at loading, a stenciled notation and other communication must accompany the part in transit for the unloading procedure.
- G. Flexible FRP components can become damaged from excessive tie-down forces. Tie-down forces should be spread over a sufficient area to prevent part crushing, and applied to supporting framework, connections, or other approved locations to prevent part damage, excessive deflection, or movement during transit.

CHAPTER 8 ■ Loading and Delivery**8.3 TRANSIT AND LIFTING EQUIPMENT**

Care must be taken by the FRP manufacturer and contractor to ensure that the FRP product does not crush or excessively flex during lifting. Spreader bars, straps, and strong backs should be used as necessary to spread forces over a sufficient lifting area. Generally, where the aspect ratio of a part is high or the laminate wall is thin, lifting attachments may be required at multiple points, to distribute the load equally. Any lifting should be approved by the FRP manufacturer prior to offloading.

Thin sections at the edge of a laminated part must always be protected per manufacturer's instructions and should never be used as a fastening point without adequate engineering. Care should be taken to ensure that lifting devices do not damage flanges and/or returns.

When FRP components are being lifted by a cable, a guide line should be attached to prevent impact damage caused by contact with other objects. Wind forces must be considered when rigging and lifting the lightweight FRP components.

8.4 TEMPORARY STORAGE

While in storage or any time prior to installation, FRP parts should be placed on firm, level, and clean, non-staining surfaces. FRP architectural products should not be allowed to rest on rocks, tools, chocks, or other uneven objects. Tools, equipment, or other construction materials should not be put to rest on FRP architectural products. When stored outdoors, FRP materials should be adequately secured to prevent movement from water flotation, wind, or impact from adjacent parts. FRP products should also be sufficiently supported to prevent warping or excessive deflections due to self-weight.

CHAPTER 9

Installation

CHAPTER 9 ■ Installation

Efficient installation of FRP components, parts, and assemblies will occur when the manufacturer, erector, shipper, and general contractor develop a coordinated installation plan. Loading and unloading, sequencing, handling, storage, lifting points and methods, and connection-point identification methods should be reviewed and approved.

The FRP manufacturer should provide advice to the installer regarding unique installation methods of the FRP parts. Often FRP products can be handled with lighter equipment than that required for other building materials. The installation contractor should be familiar with the product and should communicate installation procedures with the FRP manufacturer prior to installation.

9.1 UNLOADING AND PART INSPECTION

Care should be taken to unload FRP parts to avoid damage. Refer to Section 8.2 for guidance in lifting FRP products. Project documents regarding the procedure for part inspection and acceptance of offloaded parts should be reviewed. Care should be taken to identify parts with defects.

9.2 ERECTION

The FRP composites manufacturer should be consulted regarding the details of connection points, anchors, and the extent to which the manufacturer will provide miscellaneous back-up fasteners. The manufacturer should also be consulted for lifting techniques, restraint of panels to control movement, centers of gravity, and anchor tolerances.

Special attention should be given to alignment procedures since FRP composites fabrication methods allow for variance in panel thickness. As a result, installation documents should clearly identify panel edges for panels that differ only in edge-thickness dimensions. Alignment procedures should consider panel faces and edges for reference if necessary, rather than simply relying on anchors and/or stiffening frames.

Installation of large components may require knowledge of the center of gravity. Shop drawings should be reviewed.

9.3 CLEANING

Smudges or other temporary marks may occur during the installation process. Due to the variety of finishes available on FRP products, care must be taken when cleaning and preparing the product after installation. The installer or contractor must contact the FRP manufacturer to determine the proper cleaning procedures for the installed product.

9.4 REPAIR

FRP architectural components might be damaged during transportation or installation. It is not uncommon to experience damage during large or complicated installations. FRP composites can be repaired either before or after installation. Should a repair be necessary, the contractor or installer should consult with the registered design professional and the FRP manufacturer to develop a repair procedure to restore the integrity of the FRP component. Refer to Section 4.7 - REPAIR to determine the type of repair before beginning any work.

9.5 MISALIGNMENT

The registered design professional and FRP manufacturer should be notified prior to any panel adjustment, such as newly drilled bolt holes, required due to misalignment. Refer to section 4.3 of the ANSI/ACMA/PIC –Standard Practice – 2011 for procedures related to drilling, sawing, or cutting FRP materials. Refer also to Section 6, EUROCOMP Design Code and Handbook (2005).

Drill bits and other equipment used in fixing misalignments differ between FRP materials and standard materials such as metals. The same holds true for acceptable edge and end distances. Repairs of areas transferring structural forces or areas critical to appearance should be inspected and approved by a qualified personnel and/or a project design team member prior to service load re-application or re-installation.

9.6 JOINT SEALANT

Procedures for applying joint sealant should follow the requirements as specified in the contract documents or shop drawings. A minimum panel return flange of 1½ inch (36mm) to 2 inches (50mm), is recommended for use at such joints. Care should be taken to properly clean and prepare the FRP composite surface prior to sealant application. The molding process may leave residual waxes or mold release agents on the panel return which must be removed to ensure sealant adhesion. All guidelines and recommendations of the sealant manufacturer should be followed.

9.7 FASTENER TORQUE

Excessive torque or undersized washers may result in FRP part damage. The torque applied to bolted connections as well as washer size and type should follow the requirements specified in the contract documents, shop drawings, or installation instructions. The installer should review these documents prior to the installation of FRP components. The registered design professional and FRP composite manufacturer should be consulted if the contract documents do not clearly define fastener torque and washer information.

GLOSSARY OF TERMS

GLOSSARY OF TERMS

ADDITIVE

Any material used to modify the properties of polymer resins. Categories of additives include reagents, fillers, viscosity modifiers, pigments, and others.

ANTIMONY TRIOXIDE

Fire retardant additive used synergistically with halogenated resins.

BARCOL HARDNESS

A measure of surface hardness made with a Barcol Impresser instrument in accordance with ASTM D2583. The hardness value can be used as an indication of the degree of cure of FRP laminates.

BI-DIRECTIONAL (BI-AXIAL)

Term to describe reinforcing fibers that are arranged in two directions, usually at right angles to each other.

CATALYST

Colloquial name for a substance that is added to the resin or gelcoat to initiate the cure. Technically, a *catalyst* is considered an *initiator*.

CHALKING

A surface phenomenon in the form of a powdery film that appears lighter than the original color. The appearance of chalking indicates the degradation of a cosmetic surface.

CHOPPED STRAND MAT

A fiberglass reinforcement consisting of short strands of fiber arranged in a random pattern and held together with a binder.

COMPOSITES

Materials composed of a reinforcing fiber in a resin matrix, often including a core material. A composite's cumulative properties are superior to those of the individual materials.

COMPRESSIVE MODULUS

A mechanical property description which measures the slope of the compressive stress-strain curve. The calculation is described in the ASTM D695 Standard.

COMPRESSIVE STRENGTH

The stress a given material can withstand when compressed. The calculation is described in the ASTM D695 Standard.

CROSS-LINKING

The chemical bonding of molecules which in polymers occurs in the free radical curing as the resin transitions from a liquid to a solid.

CURE

The completion of the cross-linking process during which a composite develops its full strength.

DENSITY

A comparison of weight per volume or mass per volume.

DIELECTRIC STRENGTH

The value of a material as an electrical insulator, or its resistance to the flow of electric current.

E-GLASS

Originally formulated for use in electric circuitry, E-glass is the most common glass formulation used in fiberglass reinforcements.

EPOXY RESIN

A polymer resin characterized by epoxide molecule groups.

FABRICATOR

The manufacturer of a product; herein related to FRP composites products.

FIBER GLASS

Glass that has been attenuated into extremely fine filaments. These filaments vary in diameter from 9–32 microns. Glass filaments are treated with special sizings and binders and processed similarly to textile fibers. These fibers come in many forms such as roving, mats, fabrics, and non-woven, or veil.

FIBER REINFORCEMENT

A fiber which when encapsulated in a polymer resin matrix, forms a composite or laminate. Also refers to a structural member designed to stiffen a molded part.

GLOSSARY OF TERMS

FILLERS

Usually inert organic or inorganic materials that are added to plastics, resins, or gelcoats to vary the properties, extend the volume, or lower the cost of the article being produced.

FIRE RETARDANTS

Compounds mixed with the resin to reduce flammability.

FIRE-RETARDANT RESIN

A thermoset resin that has been specifically formulated to reduce the flame-spread and/or smoke-generation characteristics.

FLAMMABILITY

A measure of a material's surface burning characteristics which relates to the material's propensity to spread fire (fire growth) when exposed to an ignition source (source fire). Flammability is determined by an ASTM E84 test.

FLEXURAL MODULUS

A mechanical property that measures the slope of the flexural stress-strain curve. The calculation is described in the ASTM D790 Standard.

FOAM

A lightweight, cellular plastic material containing gas-filled cells. Typical foams include urethane, PVC, or PET.

FRP

Fiber Reinforced Polymers, also known as GFRP (Glass-Fiber Reinforced Polymer), GRP (Glass Reinforced Polymer), RP (Reinforced Polymer), and Composites.

GELCOAT

A surface coat of a specialized polyester resin, either colored or clear, providing cosmetic enhancement and weatherability to a fiberglass laminate.

HAND LAY UP

The process of manually building up layers of fiberglass and resin using hand rollers, brushes, and spray equipment.

INTUMESCENT

Term describing a fire-retardant technology that causes an otherwise flammable material to foam when exposed to heat, forming an insulating carbon-char barrier under such conditions.

LAMINA (PLY)

A single layer of laminate. Each lamina, or ply, contains fibers oriented in a specific direction relative to the longitudinal axis of the FRP part.

LAMINATE

A set of laminas, or plies, stacked in a "stacking" sequence, bonded together to produce a plate, shell, or other shape.

MATRIX

The liquid component of a composite or laminate that cures to encapsulate the reinforcing fibers.

MODULUS OF ELASTICITY

An engineering mechanical property indicating the slope of a compressive, tensile, or flexural stress-strain curve. The property is useful in determining engineering performance parameters such as the expected deflection of a material or component under short- or long-term loading.

PHENOLIC

A thermosetting resin produced by the condensation of an aromatic alcohol with an aldehyde, particularly of phenol with formaldehyde.

PIGMENT

A colorant added to gelcoat or resin.

POLYESTER RESIN (unsaturated)

The product of an acid-glycol reaction commonly blended with a monomer to create a polymer resin. In its thermosetting form, it is the most common resin used in the FRP industry.

POROSITY

A term used to describe voids within a substance. Regarding FRP materials, the term is often used to describe the volume of entrapped gas bubbles or voids in a gelcoat film.

GLOSSARY OF TERMS

PRINT-THROUGH

A distortion in the surface of a part which allows the pattern of the core or reinforcement to be visible through the surface. Also known as *print out*, *telegraphing*, or *read through*.

SANDWICH CONSTRUCTION

A laminate with two composite skins separated by, but bonded to, a structural core material. Used to create stiff, lightweight structures.

SHEAR FORCE OR STRESS

A term in engineering used to describe the force or stress that is parallel to a given plane cut through a material or component. The shear between plies of a laminate is referred to as “interlaminar” or “interlaminar shear”. The shear experienced by a core material is referred to as “core shear”.

SPECIFIC GRAVITY

The ratio between the density of a given substance and the density of water.

SYNTACTIC FOAM

A low-density foam made by mixing microspheres with a resin.

TENSILE ELONGATION

An engineering term referring to the amount of extension a sample experiences during tensile strain. The calculation is described in the ASTM D638, ASTM D3039 Standards.

TENSILE STRENGTH

A measurement of the tensile stress a sample can withstand. The calculation is described in the ASTM D638 Standard.

THERMAL COEFFICIENT OF EXPANSION

A measure of the dimensional change of a material when heated or cooled; calculated in inches per inch per degree.

THERMOPLASTICS

A group of plastic materials that become elastic or melt when heated, and return to their rigid state at room temperature. Examples are PET, PVC, ABS, polystyrene, polycarbonates, and nylon.

THERMOSETS

Materials that undergo a chemical cross-linking reaction when transitioning from liquid to solid or semisolid. This reaction is irreversible. Typical thermosets are unsaturated polyester, acrylic, epoxy, and phenolic resins.

UNIDIRECTIONAL

A material whose strength lies mainly in one direction. A glass reinforcement in which the fiber is oriented in one direction.

WATER ABSORPTION

The amount of water that a laminate will absorb.

WOVEN ROVING FABRIC

Heavy fabrics woven from continuous filament in roving form.

APPENDIX A

Characteristics of FRP Composites

APPENDIX A ■ Characteristics of FRP Composites**Appearance flexibility**

An extremely wide range of textures, shapes, and colors is achievable when manufacturing parts or building components with FRP materials. Various combinations of pigments, fine aggregates, and durable metallic powders can be added to the actual laminate in order to reduce or eliminate the need to paint the FRP composite products.

Design flexibility

An FRP design begins by considering liquid polymer resins and formable reinforcing fibers. The finished component, or part, can be curved, corrugated, ribbed, or contoured into a variety of shapes. Unlike homogeneous materials, the design of an FRP laminate, component, or system can be tailored at the material level to increase the strength and stiffness of the finished product.

High strength with low unit weight

FRP materials are one of the strongest commercial materials available. Pound for pound, FRP is stronger in many ways than conventional construction materials. FRP's toughness allows thin sections to be used; stiffness can be acquired by the use of structural core materials, without substantially increasing weight.

Corrosion resistance

Unlike metals, FRP materials do not suffer from corrosion/rusting. Materials fabricated from FRP have a longer service life in corrosive environments and perform extremely well in damp environments or even submerged in fresh and salt water.

Durability

FRP products have weathered climate extremes since their introduction during World War II. As a result, FRP architectural parts can often reduce long-term maintenance costs when compared to many traditional materials.

Parts consolidation

A single FRP structure can replace an assembly of many parts and fasteners. This feature saves time, reduces assembly costs, and has given rise to the "cascade effect" of benefits for the user: For example, lighter equipment, smaller work crews, and lighter supporting structures can be used during installation.

Light transmission

FRP panels can be made translucent. This is a unique property among structural materials. FRP components can simultaneously provide structure and enclosure, while providing natural or artificial light.

Reproducibility and matching

As architectural components are molded from a durable mold, FRP replicates are identical to each other. When molds are taken from existing shapes, FRP materials faithfully reproduce the original shape, feature, and texture. This attribute has made the material a dependable source for making replications of countless historic building ornamentations and parts for historic preservation projects.

Low thermal conductivity

FRP performs extremely well in harsh environments including subzero to high ambient temperatures. Composite materials do not easily thermally conduct; thus they provide excellent insulation. FRP composite products can be found in building doors, panels, and windows for extra protection from severe weather. They perform well in tropical as well as arctic regions.

Fire characteristics

FRP systems can be designed to meet all the reaction-to-fire requirements mandated in the International Building Code sections related to interior finish, light-transmitting materials, and external assemblies.

Radar transparency

Most glass-fiber-based FRP composites are transparent to radar and radio frequencies. This attribute enables composite products to be used as decorative canopies or enclosures, designed to hide communications equipment on top or within building structures.

APPENDIX A ■ Characteristics of FRP Composites**Dimensional stability**

FRP composites behave similarly to most materials in that they expand and contract due to changes in temperature. The coefficient of thermal expansion (CTE) varies with the content and type of resin and reinforcement used, as well as with the direction of the fiber. Typically, the CTE of glass-fiber-reinforced unsaturated polyester resin is $14\text{--}22 \times 10^{-6}$ in/in/°F ($25\text{--}40 \times 10^{-6}$ mm/mm/°C). Most carbon fibers have a negative CTE and the result is a contraction in the fiber when temperature is increased. However, a properly designed carbon/epoxy laminate can be manufactured with a zero CTE.

Nonconductive

Typically FRP composites are insulators. They are used for utility poles, stand-off insulators, and other applications where electrical conductivity is disadvantageous. An exception is carbon fiber, which alone is conductive. Although thermoset resins are non-conductive, fillers can be utilized to induce conductive or semi-conductive behavior if desired.

Nonmagnetic

FRP composite parts manufactured with glass fiber and traditional thermoset resins are non-magnetic. Magnetism can be engineered into FRP composite laminates through the incorporation of magnetically responsive fillers or fibers.

[RETURN TO TEXT: Characteristics of FRP Composites](#)

APPENDIX B

The History of FRP Composites

APPENDIX B ■ The History of FRP Composites

The concept of “composite” building construction has existed since ancient times. Civilizations throughout the world have used basic elements of their surrounding environment to create a composite useful in the fabrication of dwellings. Examples include mud/straw and wood/clay composites. “Bricks” were and still are made from mud and straw. The mud acts much like the resin in FRP composites construction and the straw as the reinforcement, holding the brick together during the drying (and shrinkage) process. In the “wattle and daub” method of constructing walls, vertical wooden stakes (wattles) were woven with horizontal twigs and branches then daubed with clay or mud. This is one of the oldest known methods for making waterproof structures and uses the same principle as modern composites.

While the concept of composites has been in existence for several millennia, the incorporation of FRP composites technology into the industrial world is less than a century old. The true “age of plastics” emerged just after 1900 when chemists and industrialists took bold steps to have plastics (vinyl, polystyrene, and Plexiglas) mimic and outdo nature’s own materials. Spurred on by the needs of electronics, defense, and eventually aerospace technologies, researchers created materials with properties that seem to defy known principles, such as the Kevlar fiber composites used to stop bullets. The first known FRP product was a boat hull manufactured in the mid 1930s as part of a manufacturing experiment using a fiberglass fabric and polyester resin laid in a foam mold. From this somewhat inauspicious beginning, FRP composites applications have revolutionized entire industries, including aerospace, marine, electrical, corrosion-resistance, and transportation.

FRP composites materials date back to the early 1940’s in the defense industry, particularly for use in aerospace and naval applications. The U.S. Air Force and Navy capitalized on FRP composites’ high strength-to-weight ratio, resistance to weather, and resistance to the corrosive effects of salt air and sea. By 1945, over seven million pounds of fiberglass were used, primarily for military applications. Soon the benefits of FRP composites, especially their corrosion resistance, became known to the public sector. Fiberglass pipe, for instance, was introduced in 1948 for what has become one of its widest areas of use within the corrosion-resistance market: the oil industry. FRP composites proved to be a worthy alternative to traditional materials even in the high-pressure, large-diameter situations of chemical processing. Besides superior corrosion resistance, FRP pipe offered both durability and strength thus eliminating the need for interior linings, exterior coatings, and/or cathodic protection. Since the early 1950s, FRP composites have been and still are used extensively for equipment in a variety of industries, such as chemical processing and storage, pulp and paper, power, waste treatment, mining, metals refining, and other manufacturing sectors. Myriads of products and FRP installations helped build a baseline of proven performance in the field in such products as chemical plant scrubbers, hoppers, hoods, ducts, fans, stacks, piping, pumps and pump bases, valve bodies, and above-ground as well as underground tanks for chemicals or gasoline.

The decades after the 1940’s brought new and often times revolutionary applications for FRP composites. The same technology that produced the reinforced plastic hoops required for the government’s nuclear bomb “Manhattan Project” during World War II, spawned the development of high-performance FRP composites materials for solid rocket motor cases and tanks in the 60s and 70s. In fact, fiberglass-wall tanks were used on the Skylab orbiting laboratory to provide oxygen for the astronauts. In 1953, the first production Chevrolet Corvettes with fiberglass body panels rolled off the assembly line. Now, high-performance racecars are the proving ground for technology transfer to passenger vehicles.

In the 1960s, the British and U.S. Navies were simultaneously using FRP composites to develop minesweeper ships as such composites are not only superior to other materials in a harsh marine environment, they are also non-magnetic. It was also noticed at that time that one of the features of FRP is the ability of the materials to reduce the radar signature of a structure, such as a ship or an aircraft. High-performance composites materials have been demonstrated in advanced technology aircraft such as the F-117 Stealth Fighter and B-2 Bomber. Currently, FRP composites are being used for space applications and are involved in several NASA test initiatives.

APPENDIX B ■ The History of FRP Composites

The marine market was the largest consumer of composites materials in the 1960s. In the 1970s, the automotive market surpassed marine as the number one market, a position it retains. Composites have also impacted the electrical transmission market with products such as pole-line hardware, cross-arms, and insulators.

While the majority of the historical and durability data of FRP composites installations comes from the aerospace, marine, and corrosion-resistance industries, FRP composites have been used as a construction material for several decades. FRP composites products were first demonstrated to reinforce concrete structures in the mid 1950s. In the 1980s, there was a resurgence of interest in composites as reinforcing agents when new developments made it possible to apply FRP reinforcing bars in concrete that required special performance requirements, such as non-magnetic properties or chemical resistance.

The public became familiar with FRP as a construction material in the 1950s with its use in residential carports and patio covers. Additional awareness was gained through the 1957 construction of MIT's "House of the Future" at Disneyland, sponsored by Monsanto. While the futuristic, cantilevered pod design did not catch on as a popular residential construction choice, the materials demonstration was an unqualified success. The exhibit withstood over 2 million visitors per year and several minor earthquakes in its decade as a demonstration project. The "House of the Future" exhibited the structural durability of composites to the end when a wrecking ball proved ineffective at taking down the FRP composites structure. After the ball bounced off the structure's surface, the site was cleared only through cutting the building into pieces.

The 1964 New York World's Fair continued the introduction of varieties of fiberglass architectural construction where the fiberglass material was employed in semi-permanent structures. Generally, these were also of advanced design and represented the first category of architectural design style using composites.

Another architectural usage of FRP is in the reproduction or restoration of historic buildings. The balustrade of the rear facade of The White House, home to U.S. Presidents, has been restored using FRP components. Countless other Colonial and Victorian restoration projects owe their success to reinforced polymers. The restoration or reproduction of cupolas, steeples, and other distinctive structures is made possible through these "space age" materials.

A third category of architectural construction using FRP is represented by functional and structural combinations. The controversy over the appearance of communications equipment on the Sun Bank Building in Orlando, Florida was resolved through the use of FRP. Molded support shrouds conceal service and communications equipment, while producing a visually dramatic skyline. Many uses of fiberglass at recreational sites also involve structural FRP. Additionally, since FRP is much stronger per pound than conventional materials, it often reduces the need for the supporting structure required for non-load-bearing cladding and other building envelope applications.

During the late 1970s and early 1980s, the value of many FRP products was demonstrated in infrastructure applications in Europe and Asia. In 1986, the world's first highway bridge using composites reinforcing tendons was built in Germany. The first all-composites bridge deck was constructed in China. The first all-composites pedestrian bridge was installed in 1992 in Aberfeldy, Scotland. In the U.S., the first FRP-reinforced concrete bridge deck was built in 1996 at McKinleyville, West Virginia followed by the first all-composites vehicular bridge deck in Russell, Kansas. Numerous FRP composites pedestrian bridges have been installed in U.S. state and national parks in remote locations not accessible by heavy construction equipment, or for spanning over roadways and railways. Today, there are over 400 installations in North America using composites products such as bridge deck panels, rebar, tendons, girders, marine piling and bridge-pier protection systems, and dowel bars for concrete pavements. In addition, there are thousands of installations in North American and worldwide where FRP composites systems have been used to strengthen or seismically upgrade reinforced concrete or masonry structures ranging from buildings and parking garages to bridges, structural columns, or decks.

APPENDIX B ■ The History of FRP Composites

The use of FRP composites has transformed the marine, automotive, and aerospace markets. Many specific applications in infrastructure and chemical processing have seen similar dramatic conversions. There is huge potential for a similar technology shift in the architectural and building and construction segments as the building industry takes advantage of the design flexibility, durability, low weight, corrosion resistance, and other properties that composites offer.

[RETURN TO TEXT: Where are FRP Composites Used?](#)

APPENDIX C

FRP Composites Architectural and Building Applications

APPENDIX C ■ FRP Composites Architectural and Building Applications

- Acoustic Panels
- Architectural Ornaments
- Architectural Cladding including Rain Screens
- Artificial Stone for Landscaping
- Balcony Decks and Railing
- Balustrades, Posts, and Railings
- Baseboard
- Bath and Shower Units
- Brackets
- Chair Rails
- Columns
- Cornices
- Countertops
- Crown Moldings
- Door Pediments
- Door Skins
- Electrical Cabinets
- Electrical Insulators
- Exterior Cladding
- Facades
- Fencing
- Finials
- Fountains
- Furniture
- Grating – Walkways and Railing
- Gutters
- Handrails
- Panels – Exterior
- Panels – Light-Transmitting
- Pergolas
- Planters
- Porticos
- Rooftop Communications Housing
- Roof Structures – Domes, Cupolas, Steeples
- Sculptures
- Shutters
- Signage
- Sinks
- Skylights
- Soffit
- Staircases
- Structural Profiles
- Sun Rooms
- Translucent Surfaces
- Trim – Decorative and Historical Restoration
- Wall panels – Curtain Walls
- Window Envelope – Dormers, Lintels, Bays and Surrounds, Mullions
- Window Lineals

[RETURN TO TEXT: Architectural Applications](#)

APPENDIX D

FRP Composites Raw Materials

APPENDIX D ■ FRP Composites Raw Materials

The building blocks of FRP construction for architectural products are thermosetting and thermoplastic resins, fiber reinforcements (most often glass), and frequently structural core materials. The resin provides a rigid matrix, which encapsulates and holds the load-bearing fiber reinforcement. The wide diversity of FRP materials is an attribute that makes them excellent engineering materials while introducing a level of complexity that must be clearly understood to achieve desired results. Many types of resins, reinforcements, core materials, and additives can be combined to design very specific properties into the final component, or part. Each of these materials, individually, varies in cost, durability, strength, and resistance to fire or other performance attributes.

D.1 POLYMER RESINS

There are two major family groups of plastic resins: Thermoplastics and Thermosets.

Thermoplastic Resins are characterized by materials such as ABS, polyethylene, polystyrene, and polycarbonate. These resins are recognized by their capability to be melted and formed (or molded) and then reheated once again to the “plastic” state.

Thermoset Resins are most commonly employed in architectural FRP products. This group of resins is characterized by the ability to convert from liquid form to solid form through polymerization and cross-linking. Once polymerized (cured), thermoset resins cannot be converted back to their original state. Among the thermosetting resins used for large building components, polyester resin is by far the dominant material. Vinyl ester resins are similar to polyesters but feature enhanced corrosion resistance and toughness. Epoxy resins are used in some applications where superior resistance to corrosive chemicals is required (for example, infrastructure applications). Phenolic and modified acrylic resins are employed for superior fire retardancy and low smoke generation. Unlike most thermoplastic materials, thermoset resins do not melt.

D.2 BASIC THERMOSET RESIN CHEMISTRY

The primary functions of the resin are to transfer stress between the reinforcing fibers, act as a glue to hold the fibers together, and protect the fibers from mechanical and environmental damage. Thermoset resins, are “cured” by the use of a catalyst. Once the catalyst is introduced and the material has “cured”, a thermoset cannot be reshaped. The Heat Distortion Temperature (HDT) and Glass Transition Temperature (T_g) are physical measurements used to describe the softening of a cured resin. Two ASTM Standard test methods are available to measure HDT and T_g ([See APPENDIX F: Test Methods](#)).

The most common thermosetting resins used in the composites industry are unsaturated polyesters, epoxies, vinyl esters, polyurethanes, and phenolics. The differences between these groups must be understood in order to choose the proper material for a specific application.

D.3 RESIN MATRIX

D.3.1 UNSATURATED POLYESTERS

Unsaturated polyester resins (UPR) are the workhorse of the composites industry and represent approximately 75% of the total resins used. To avoid any confusion in terms, readers should be aware that there is a family of thermoplastic polyesters that are best known for their use as fibers for textiles and clothing, but they are not under discussion here. Thermoset polyesters are produced by the condensation polymerization of dicarboxylic acids and difunctional alcohols (glycols). In addition, unsaturated polyesters contain an unsaturated material, such as maleic anhydride or fumaric acid, as part

APPENDIX D ■ FRP Composites Raw Materials

of the dicarboxylic acid component. The finished polymer is dissolved in a reactive monomer such as styrene to give a low-viscosity liquid. When this resin is cured, the monomer reacts with the unsaturated sites on the polymer, converting it to a solid thermoset structure.

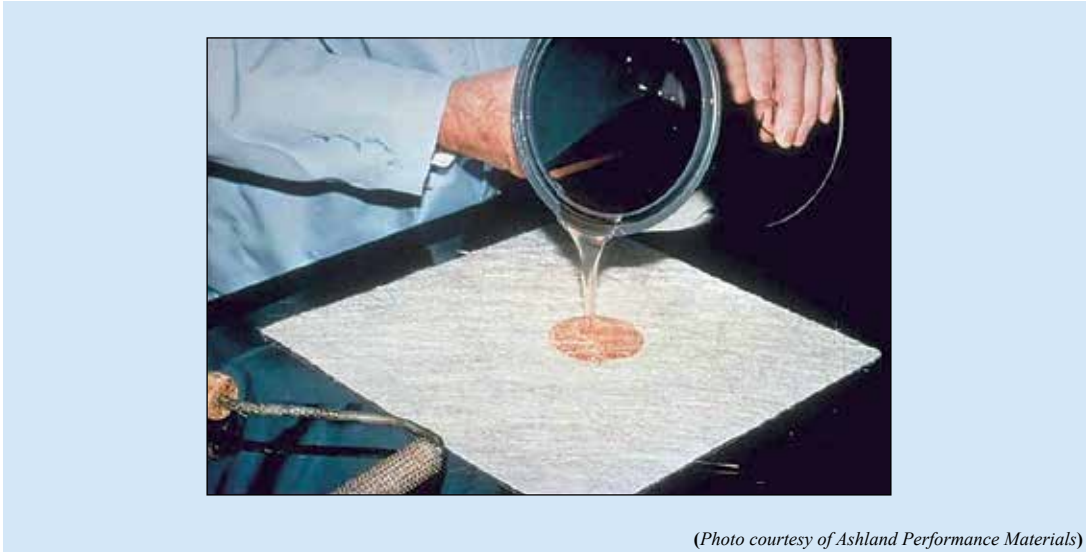

FIGURE D.3-1: Preparation of a composite using catalyzed unsaturated polyester resin and chopped strand mat

A range of raw materials and processing techniques is available to achieve the desired properties in the formulated or processed polyester resin. Polyesters are versatile precisely because of their capacity to be modified or tailored during the building of the polymer chains. They have been found to have almost unlimited uses in all segments of the composites industry. The principal advantage of these resins is a balance of properties (including mechanical, chemical, and electrical), dimensional stability, relatively low cost, and ease of handling or processing.

Unsaturated polyesters are divided into classes depending upon the structures of their basic building blocks. Some common examples are orthophthalic (“ortho”), isophthalic (“iso”), dicyclopentadiene (“DCPD”), and bisphenol-A-fumarate resins. In addition, polyester resins are classified according to end-use application as either general purpose (GP) or specialty polyesters such as fire retardant (FR).

Polyester producers have proved willing and capable of supplying resins with the necessary properties to meet the requirements of specific end-use applications. These resins can be formulated and chemically tailored to provide project-specific properties and manufacturing-process compatibility.

D.3.2 EPOXIES

Epoxy resins have a well-established record in a wide range of composites parts as well as in concrete repair. The structure of the resin can be engineered to yield a number of different construction products with varying levels of performance. A major benefit of epoxy resins over unsaturated polyester resins is their reduced shrinkage upon curing. Epoxy resins can also be formulated with different materials or blended with other epoxy resins to achieve specific performance features. Cure rates can be controlled to match process requirements through the proper selection of hardeners and/or catalyst systems. Generally, epoxies are cured by addition of an anhydride or an amine hardener as a 2-part system. Different hardeners, as well as different quantities of hardener, will produce different cure profiles and different properties in the finished composites.

APPENDIX D ■ FRP Composites Raw Materials

Epoxies are used primarily for fabricating high-performance composites with superior mechanical properties, resistance to corrosive liquids and environments, superior electrical properties, good performance at elevated temperatures, good adhesion to a substrate, or a combination of these benefits. Epoxy resins do not, however, have particularly good UV resistance. Another drawback is that since the viscosity of epoxy is much higher than that of most polyester resins, a post-cure (elevated-heat) process is often required to obtain ultimate mechanical properties. However, epoxies emit little odor as compared to polyesters.

Epoxy resins are used with a number of fibrous reinforcing materials including glass, carbon, and aramid. Aramid-fiber-construction applications are uncommon because of the comparatively high material cost, but cost-effective applications do exist if certain high-strength, stiffness, and/or toughness combinations are required. Epoxies are compatible with most composites manufacturing processes, particularly vacuum-bag molding, autoclave molding, pressure-bag molding, compression molding, filament winding, and hand lay up.

D.3.3 VINYL ESTERS

Vinyl esters were developed to combine the advantages of epoxy resins with the better handling/faster cure times typical of unsaturated polyester resins. Vinyl ester resins are produced by reacting epoxy resin with acrylic or methacrylic acids. The resulting material is dissolved in styrene to yield a liquid that is similar to a polyester resin. Vinyl esters are also cured with the conventional organic peroxides found in polyester resins. Vinyl esters offer mechanical toughness and excellent corrosion resistance. These enhanced properties are obtained without the complex processing, handling, or special shop-fabrication practices typical in the production of epoxy resins.

D.3.4 PHENOLICS

Phenolics are a class of resins commonly based on phenol (carbolic acid). Phenolics are thermosetting resins that cure through a condensation reaction producing water that should be removed during processing. Pigmented applications are typically limited to red, brown or black. Phenolic composites have many desirable performance qualities including high-temperature resistance, creep resistance, excellent thermal-insulation and sound-damping properties, corrosion resistance, and excellent resistance to fire, smoke, and smoke toxicity. Phenolics are applied as adhesives or matrix binders in engineered woods (plywood), and are found in brake linings, clutch plates, circuit boards, and subway car panels.

D.3.5 POLYURETHANES

Polyurethanes are a family of polymers with widely ranging properties and uses, all based on organic polyisocyanate with a polyol (an alcohol containing more than one hydroxyl group). A few basic constituents of different molecular weights and functionalities are used to produce the whole spectrum of polyurethane materials. The versatility of polyurethane chemistry enables the polyurethane chemist to engineer polyurethane resin to achieve desired mechanical or electrical properties.

Polyurethanes appear in an amazing variety of forms. These materials are all around us, playing important roles in more facets of our daily life than perhaps any other single polymer. They are used as a coating, elastomer, foam, or adhesive. When used as a coating in exterior or interior finishes, polyurethanes are tough, flexible, chemical resistant, and fast curing. As an elastomer, polyurethanes have superior toughness and abrasion in such applications as solid tires, wheels, bumper components, or insulation. There are many formulations of polyurethane foam used to optimize the density of

APPENDIX D ■ FRP Composites Raw Materials

insulation, structural sandwich panels, and architectural components. Polyurethanes are often used to bond FRP composite structures together. The benefits of polyurethane adhesives include improved impact resistance over other adhesives or resins, rapid curing, and the ability to bond well to a variety of different surfaces, such as concrete.

D.3.6 SUMMARY OF RESINS

Although the vast majority of architectural composites products use unsaturated polyester resins (UPR), one of the great design strengths of composites is the multiple choices of resins. In order to make effective use of these choices, designers and product specifiers should be familiar with the properties, advantages, and limitations of each of the common FRP composite resins. It is common to use the resources of the resin manufacturer's laboratories to determine the best resin for an application.

D.4 FIBER REINFORCEMENTS

Glass fiber is the predominant reinforcement used in FRP architectural products. Other, higher modulus fiber reinforcements, including carbon and aramid fiber, are also used in composites. However, these materials are employed almost exclusively in aircraft, aerospace, high technology recreational products, and medical applications. Carbon-fiber structural components make sense where improved modulus, strength, and durability properties warrant their high cost. Carbon fibers are used frequently in external strengthening systems for concrete repair and seismic upgrade.

Figures D.4-1 to D.4-3 show a few commercially available glass-fiber architectures. Carbon fiber is shown in Figure D.4-4.

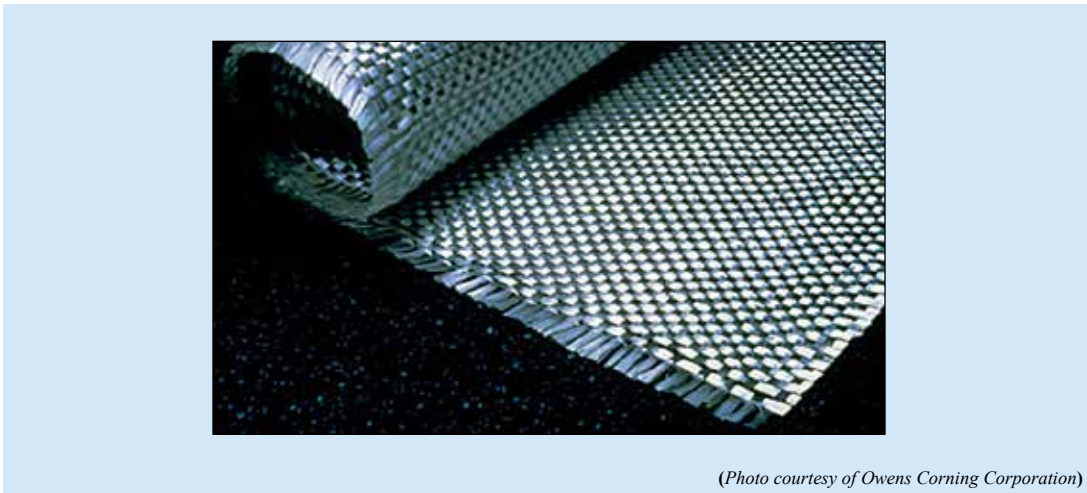

FIGURE D.4-1: Glass-fiber-woven roving ply, with fibers in two orthogonal directions [0/90] to the sheet direction

APPENDIX D ■ FRP Composites Raw Materials



(Photo courtesy of Owens Corning Corporation)

FIGURE D.4-2: Randomly oriented fibers shown in a roll of chopped strand mat



(Photo courtesy of Owens Corning Corporation)

FIGURE D.4-3: Single-end roving for pultrusion

APPENDIX D ■ FRP Composites Raw Materials



FIGURE D.4-4: Carbon-fiber-woven roving ply, with fibers in two orthogonal directions, [0/90] to the sheet direction

TABLE D.4-1: Glass Fiber Types (IS ISO-2078 – Table-1)

Type	General Indications
E	For general purposes: good electrical properties
D	Good dielectric properties
A	High alkali content
C	Chemical resistance
S	High mechanical strength
R	High mechanical strength
AR	Alkali resistant
E-CR	For use in acid environments

The very fine glass fiber used in the FRP-building-products industry is drawn from molten glass, composed mainly of silica sand, aluminum oxide, and calcium oxide. These very small diameter filaments are gathered into bundles known as fibers. Glass fiber is a versatile reinforcement available in a number of different forms:

- *Multi-end Roving, or Chop Roving* – An assembly of discrete fiber bundles in a larger roving, which is designed to break apart into randomly oriented fiber bundles when fed from a “creel” through a chopper gun during a spray-up process.
- *Single-end Roving, or Direct Roving* – An assembly of 2000–5800 individual filaments incorporated into a single roving bundle. These are typically used in pultrusion or filament-winding processes.
- *Continuous Filament Mat (CFM)* – A collection of randomly oriented continuous-fiber bundles consolidated in mat form with a binder.
- *Chopped Strand Mat (CSM)* – A mat formed of randomly oriented chopped fibers –approx. ½-inch- (12mm) to 1½-inches (36mm) long – held together by a binder. Commonly used in the hand-lay-up method.

APPENDIX D ■ FRP Composites Raw Materials

- *Woven Roving* – Single-end rovings which have been woven into a heavy fabric.
- *Knitted or Biaxial Fabrics* – Non-woven fabrics that contain single-end rovings in a number of different directions: 90 degrees, ± 45 degrees or combinations thereof to produce biaxial, triaxial, or quadraxial reinforcing. Primarily used for highly directional strength requirements.
- *Multi-Axial fabrics* – Layers of multiple directional plies of reinforcement.
- *Hybrid Fabric* – Fabrics containing two or more different fiber types – glass and Kevlar fiber, glass and carbon fiber, etc.
- *Textile Fabric* – A light woven material using fiberglass strands of yarn. Often referred to as “cloth”.
- *Milled Fiber* – Short-length filaments (1/32 inch (.75mm) – 1/8 inch (3mm)) used to make reinforced putties.

There are a number of different formulations of the raw glass feedstock, which create fibers having different properties.

The glass fiber reinforcement typically used in architectural products is termed “E-Glass” which possesses a good combination of properties and cost. A different glass fiber, E-CR glass, has superior acid resistance and modestly better alkali resistance. It is used in concrete reinforcement as FRP rebar, while S-Glass, a slightly different glass formula, provides superior ballistic impact resistance.

During the manufacturing process, the glass fiber is coated with a chemical sizing, or finish, which provides a bonding interface between the fiber and the resin. Usually these sizings, or finishes, are specific in their compatibility with resin types. A good bond at the “interface” of fiber and resin is essential to a composites material’s strength, resistance to moisture, and other properties.

D.4.1 SUMMARY OF REINFORCEMENTS

The mechanical properties of FRP composites are dependent on the type, amount, and orientation of fiber employed within the laminate, component, or part. There are many commercially available reinforcement forms to meet the design requirements of the user. The ability to tailor the fiber architecture allows for optimized performance of a product that translates to savings in weight and cost.

D.5 CORE MATERIALS

The introduction of a core material “sandwiched” between fiber-reinforced laminate skins can significantly increase stiffness and flexural strength while reducing the warpage, bowing, and “oil-canning” of flat surfaces. Thermal conductivity, sound insulation, and fire resistance can also be improved by use of a properly selected core material.

Three typical structural core material types are honeycomb (metallic, plastic, paper, phenolic paper), natural (end-grain balsa wood), and cellular plastic foam (PVC, PUR, PS, SAN, and PET). These cores support the surface laminates, distribute the shear forces, and provide impact resilience. Plywood is not typically referred to as a core material. Due to its rigidity it behaves as a laminate ply rather than as a load-distributing material.

APPENDIX D ■ FRP Composites Raw Materials

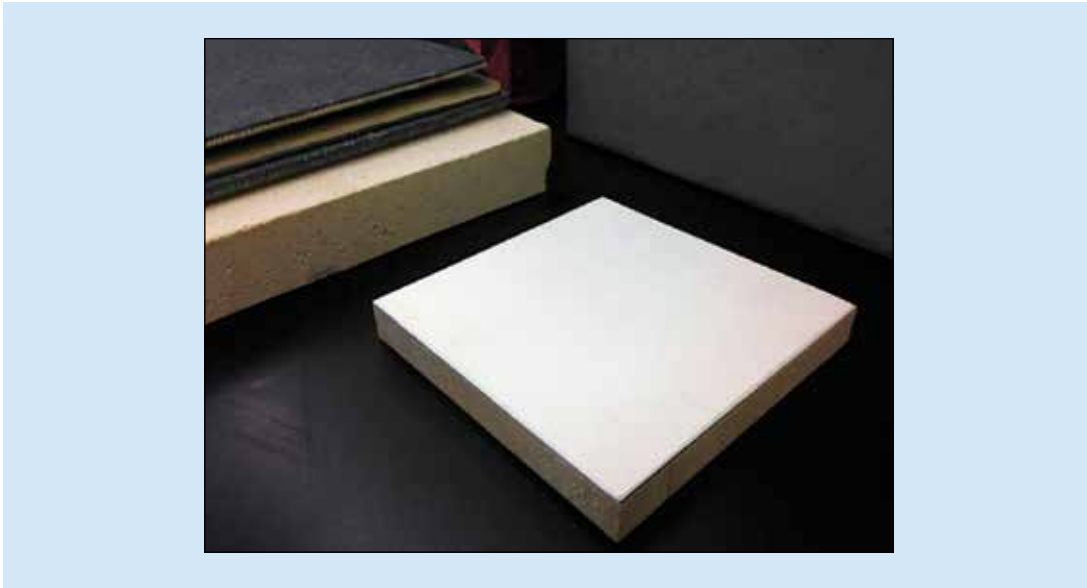

FIGURE D.5-1: Balsa wood core material

Bonded-sandwich structures have been a basic component of the composites industry for over 45 years. The concept of using relatively thin, strong face sheets bonded to thicker, lightweight core materials has allowed the industry to build strong, stiff, light, and highly durable structures that otherwise would not be practical. The bonded-sandwich technology has been demonstrated in boats, trucks, automobiles, wind turbine blades, and building panels. A 3% weight increase can increase the flexural strength and stiffness by a magnitude of 3.5 times and 7 times respectively if cores and skins are properly chosen. The structure then acts more or less monolithically.

The most common comparison is of a composite sandwich part to an I-beam. The panel skins, like the flanges of the I-beam, carry the tensile and compressive stresses during bending. The stresses are transferred between the top and bottom skins through shear stresses that run through the core or web of the I-beam. The purpose of an I-beam is to lessen the weight of the monolithic geometry required to support a given load in bending. Since the highest stresses are carried at the extremities, both the top and bottom of the I-beam, the center section can be much narrower in width in relation to the flanges. In a sandwich structure, the core will generally have the same width and length dimensions as the skins, but can be much weaker than the skins since it primarily experiences shear stresses. Care must be taken in the design to ensure that the shear carrying capability of the expected loads does not exceed that of both the core and the adhesive.

APPENDIX D ■ FRP Composites Raw Materials

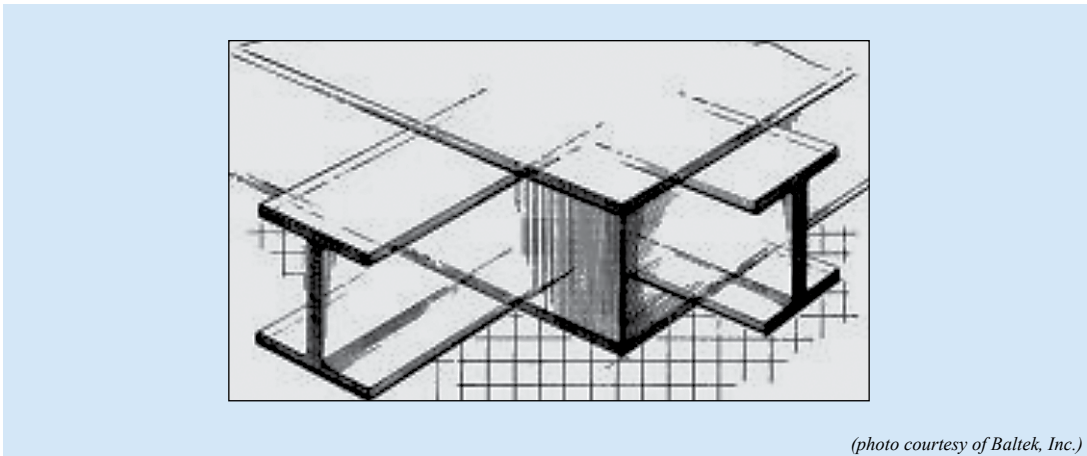

FIGURE D.5-2: Comparison of core to I-Beam

Face sheets can be of almost any material. In the composites industry, the most common face sheets are glass and carbon. Some core materials can be shaped, such as in a waffle pattern or corrugation, to achieve the desired mechanical properties.

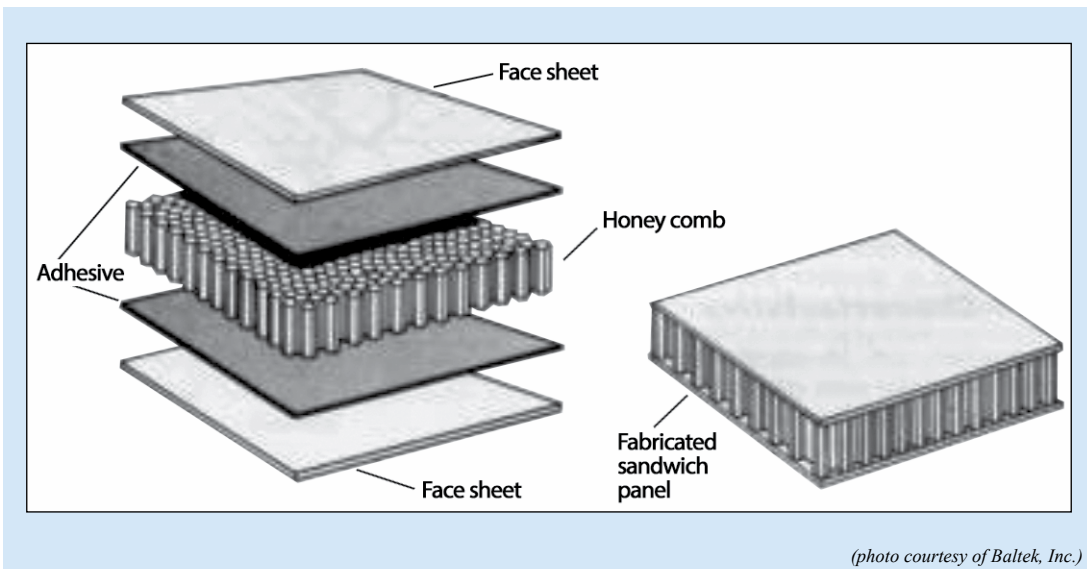

FIGURE D.5-3: Honeycomb sandwich construction

A cost-effective and superior sandwich construction uses end-grain balsa wood. This material has exceptional bond, high impact and fatigue resistance with excellent strength/stiffness and lightweight properties, along with unique self-extinguishing fire properties. Balsa has a high aspect ratio and directionally aligned cells such that the grain is oriented in the direction of the maximum stress. Balsa has a proven track record in products such as pleasure boat hulls, military aircraft, navy vessels, vehicles, wind turbine blades, and corrosion-resistant industrial tanks.

APPENDIX D ■ FRP Composites Raw Materials

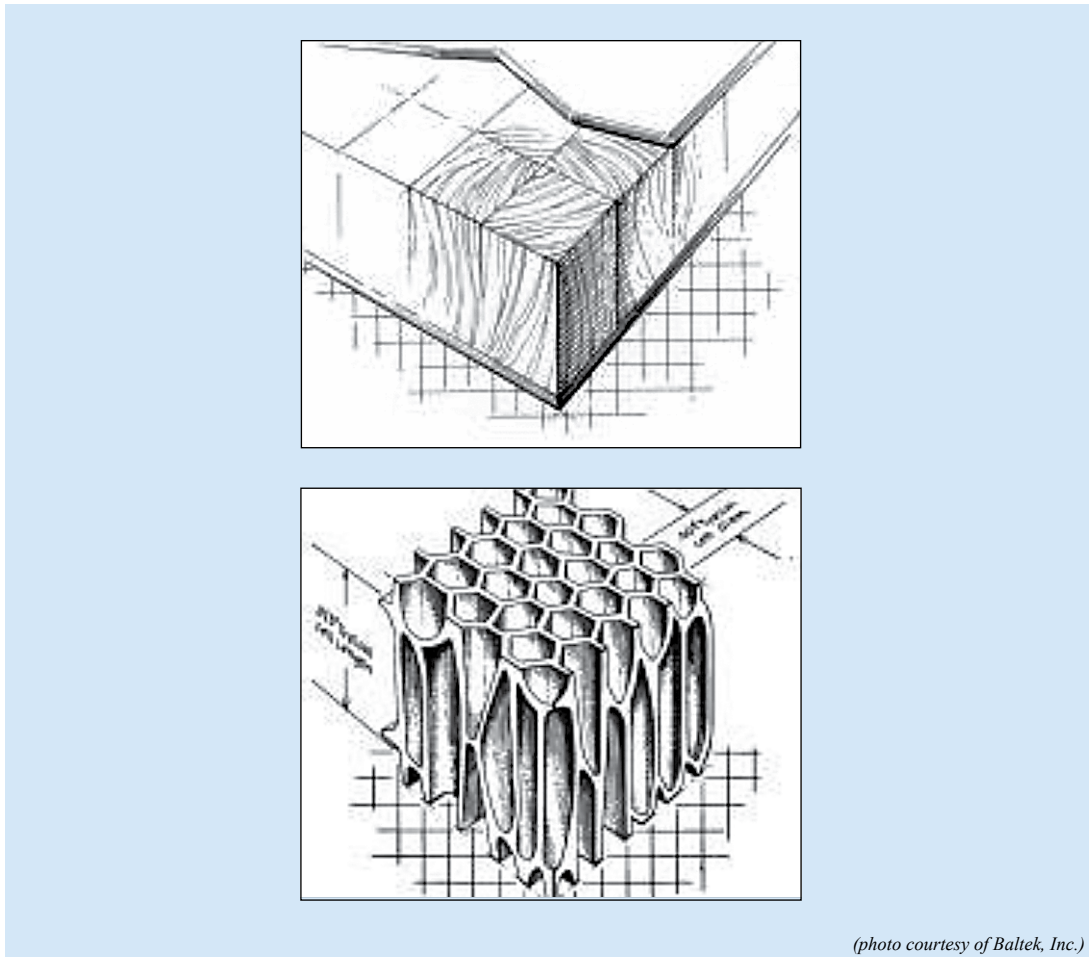

FIGURE D.5-4: Laminated sandwich construction with balsa wood

D.6 ADDITIVES

A wide variety of additives are used in composites to modify material properties and tailor the laminate's performance. Although these materials are generally used in relatively low quantity by weight, compared to resins, reinforcements, and fillers, they perform critical functions.

Additive Functions

The functions of additives used in thermoset and thermoplastic composites include the following:

Low shrink/low profile: When parts with smooth surfaces are required, a special thermoplastic resin, which moderates resin shrinkage, can be added to thermoset resins.

Fire resistance: Combustion resistance is improved by the proper choice of resin and the use of fillers or flame-retardant additives. Included in this category are materials containing antimony trioxide, bromine, chlorine, borate, and phosphorus.

Air release: Most laminating resins, gelcoats, and other polyester resins might entrap air during processing and application. This can cause air voids and improper fiber wet-out. Air-release additives are used to reduce air entrapment and to enhance fiber wet-out.

APPENDIX D ■ FRP Composites Raw Materials

Emission control: In open mold applications, styrene emission suppressants are used to lower emissions for air quality compliance.

Viscosity control: In many composites types, it is critical to have a low, workable viscosity during production. Reduced viscosity in such filled systems is usually achieved by use of wetting and dispersing additives. These additives facilitate the wet-out and dispersion of fillers resulting in a lower viscosity (and/or higher filler loading).

Electrical conductivity: Most composites do not conduct electricity. It is possible to obtain a degree of electrical conductivity by the addition of metal, carbon particles, or conductive fibers. Electromagnetic interference shielding can be achieved by incorporating conductive materials.

Toughness: Can be enhanced by the addition of reinforcements. It can also be improved by special additives, such as certain rubber or other elastomeric materials.

Antioxidants: Plastics are sometimes modified with antioxidants, which retard or inhibit polymer oxidation and the resulting degradation of the polymer.

Antistatic agents: Are added to polymers to reduce their tendency to develop an electrical charge. Control of static electricity is essential in certain plastics processing and handling operations, as well as in finished products. Static charges on plastics can produce shocks, present fire hazard, and attract dust. The effect of static charge in computer/data processing applications, for example, is particularly detrimental.

Foaming agents: Chemicals that are added to polymers during processing to form minute cells throughout the resin. Foamed plastics exhibit a lower density, decreased material costs, improved electrical and thermal insulation, increased strength-to-weight ratios, and reduced shrinkage and part warping.

Plasticizers: Added to compounds to improve processing characteristics and to increase the range of physical and mechanical properties.

Slip and blocking agents: Provide surface lubrication. This results in a reduced coefficient of friction on part surfaces and enhances the release of parts from the mold.

Heat stabilizers: Used in thermoplastic systems to inhibit polymer degradation that results from exposure to heat.

Ultraviolet stabilizers: Both thermoset and thermoplastic composites may benefit from special materials that are added to prevent loss of gloss, crazing, chalking, discoloration, changes in electrical characteristics, embrittlement, and disintegration due to ultraviolet (UV) radiation. Additives that protect composites by absorbing the UV are called *ultraviolet absorbers*. Materials that protect the polymer from UV in some other manner are known as *ultraviolet stabilizers*.

D.7 FILLERS

Inert fillers such as clay, alumina tri-hydrate, or calcium carbonate may be used as a volume substitute to reduce the resin cost. Most additives to the resin and reinforcement combination are functional fillers, which are added to the resin to impart a specific property. Fillers can reduce shrinkage, add stiffness, control opacity, add fire retardancy, improve surface finish, and minimize surface crazing, in addition to reducing overall product cost. Fillers must be chosen carefully for each application and are usually matched to specific design requirements.

APPENDIX D ■ FRP Composites Raw Materials

The use of inorganic fillers in composites is increasing. Fillers not only reduce the cost of composites but also frequently impart performance improvements that might not otherwise be achieved by the reinforcement and resin ingredients alone. Fillers can improve mechanical properties, including fire and smoke performance, by reducing organic content in composites laminates. Also, filled resins shrink less than unfilled resins, thereby improving the dimensional control of molded parts. Important properties, including water resistance, slower weathering, surface smoothness, stiffness, dimensional stability, and temperature resistance can all be improved through the proper use of fillers.

The thermosetting resin segment of the composites industry has taken advantage of the properties of fillers for many years. More recently, the thermoplastic industry has begun to make widespread use of inorganic fillers. Breakthroughs in chemical treatment of fillers that can provide higher filler loadings and improved laminate performance are accelerating this trend.

TABLE D.7-1: Fillers Most Frequently Used in FRP Architectural Projects

Filler Type	Property
Alumina trihydrate (ATH)	Extender; flame retardant; smoke suppressant
Calcium carbonate	Extender
Calcium sulfate	Flame/smoke retardant
Carbon black	Pigment and pacifier
Clay (kaolin)	Extender
Fumed silica	Thixotrope
Glass fibers	Used for higher strength, dimensional stability, heat and chemical resistance
Microspheres	Used to reduce the weight of the FRP and to improve its stiffness and impact resistance
Pigments	Pigmentation and opacity
Talc	Extender; increases stiffness, tensile strength, and resistance to creep.

D.7.1 FILLER TYPES

A number of inorganic filler materials can be used with composites:

Calcium carbonate is the most widely used inorganic filler. It is available at low cost in a variety of particle sizes and treatments from well-established regional suppliers, especially for composites applications. Most common grades of calcium carbonate filler are derived from limestone or marble and are very common in automobile parts.

Kaolin clay (hydrous aluminum silicate) is the second most commonly used filler. It is known throughout the industry by its more common material name, clay. Mined clays are processed either by air flotation or by water washing to remove impurities and to classify the product for use in composites. A wide range of particle sizes is available.

Alumina trihydrate is frequently used when improved fire/smoke-retarding performance is required. When exposed to high temperature, this filler gives off water (hydration), thereby reducing the flame spread and development of smoke. Composites used in plumbing fixtures such as bathtubs, shower stalls, and related building products often contain alumina trihydrate for this purpose.

APPENDIX D ■ FRP Composites Raw Materials

Calcium sulfate is a major flame-smoke-retarding filler used by the tub/shower industry. Other commonly used fillers include:

- Mica
- Feldspar
- Wollastonite
- Silica
- Talc
- Glass microspheres
- Flake glass
- Milled glass fibers

D.7.2 USING FILLERS IN COMPOSITES

Fillers perform a function in FRP composites similar to that of silica fume in concrete. In comparison to resins and reinforcements, fillers are the least expensive of the major ingredients. These materials are nevertheless very important in establishing the performance of the composites laminate, for the following reasons:

- Fillers may reduce the shrinkage of the composites part.
- Fillers influence the fire resistance of laminates.
- Fillers lower the cost by diluting more expensive resins and may reduce the amount of reinforcement required.
- Fillers can influence the mechanical strength of composites.
- Fillers serve to transfer stresses between the primary structural components of the laminate (i.e., resin and reinforcement), thereby improving mechanical and physical performance.
- Uniformity of the laminate can be enhanced by the effective use of fillers. Fillers help maintain fiber-loading uniformity by carrying reinforcing fibers along with the flow as resin is moved on the mold during compression molding.
- Crack-resistance and crack-prevention properties are improved with filled resin systems. This is particularly true in sharp corners and resin-rich areas where smaller particles in the filler help to reinforce the resin.
- The combination of small and medium filler particles helps control compound rheology at elevated temperatures and pressures, thereby helping to ensure that compression-molded parts are uniform.
- Low-density fillers are used extensively in marine putty and the transportation industry. They offer the lower cost of filled systems without the increases of weight that affect the performance of the final product.

APPENDIX D ■ FRP Composites Raw Materials**D.7.3 SURFACE TREATMENTS IMPROVE SOME FILLERS**

Some fillers are chemically modified by treating the surface area of the particles with a coupling agent. These coupling agents help to improve the chemical bond between the resin and filler and can reduce resin demand.

D.7.4 SUMMARY OF FILLERS

The effective use of fillers in composites can improve performance and manufacturing processes, and reduce cost. In today's market, many of the filler systems being sold are providing several different properties for the composites in one filler system. Flame/smoke resistance, shrink control, weight management, and physical properties are often modified by using a custom-designed filler package that has a blend of specialty and commodity fillers.

D.8 SURFACE COATINGS**D.8.1 GELCOAT**

Gelcoats are considered resins but have a very special purpose. A gelcoat is a specially formulated polyester resin incorporating thixotropic agents to increase the gelcoat's viscosity and non-sag properties. The gelcoat also contains fillers to improve flow properties, pigments to give the desired color, and additives that affect specific application properties such as gel time and cure. Gelcoats are primarily used for contact molding (hand or spray lay up). The gelcoat, usually pigmented, provides a molded-in finished surface that is weather and wear resistant. The gelcoat helps hide the glass reinforcement pattern that may show through from the inherent resin shrinkage around the glass fibers. Considerations for the proper selection of a gelcoat include compatibility of the underlying FRP materials to ensure good adhesion of the gelcoat, as well as the operating environment.

The most common current usage of gelcoats is "in-mold applications." That is, the gelcoat is sprayed into the mold and the laminate is applied behind it. Adhesion of the laminating resin to the gelcoat is a critical issue. Thickness of the gelcoat can vary depending on the intended performance of the composites product. Gelcoats are typically applied by spray to approximately 16-20 mils (0.003 mm) of wet film thickness. While gelcoats are not usually designed to add to the structural strength of the FRP part, gelcoats should be resilient. They should be able to bend without cracking; and they should be resistant to thermal cracking (which may occur with dramatic changes in temperature). The primary measurements of resilience are the strength and elongation within the elastic region. Gelcoats should be UV-stable and pigmented sufficiently to provide good opacity.

Gelcoats are used to improve weathering, filter out ultraviolet radiation, add flame resistance, provide a thermal barrier, improve chemical resistance, improve abrasion resistance, and provide a moisture barrier. Gelcoats are also used to improve the product appearance such as the surface of a boat hull or golf cart. A unique benefit of gelcoats is that they are supplied in many colors by the incorporation of pigments per the specification of the engineer.

APPENDIX D ■ FRP Composites Raw Materials**D.9 ADHESIVES**

Adhesives are used to attach composites to themselves as well as to other surfaces. There are several considerations involved in applying adhesives effectively. The joint or interface connection must be engineered to select the proper adhesive and application method to ensure bond strength. Careful surface preparation and cure are critical to bond performance.

Adhesives may be used in a joint design where the maximum load is transferred into the component using the loading characteristics of the adhesive and the composites material. The most common adhesives are acrylics, epoxies, and urethanes. A high-strength bond with high-temperature resistance would warrant the use of an epoxy, whereas a bond with good strength, moderate temperature resistance, and rapid cure might warrant the use of an acrylic. For applications where toughness is needed, urethane might be the adhesive of choice.

[RETURN TO TEXT: Raw Materials](#)

APPENDIX E

Fabrication Processes

APPENDIX E ■ Fabrication Processes

FRP laminates are a durable class of materials adaptable to a wide range of shapes and sizes. The manufacturing processes used to produce FRP composite parts can accommodate a one-time molded part or high production quantities. The two most commonly used open molding techniques are *hand lay up* and *spray up*, but *vacuum-assisted resin-transfer molding* processes are becoming more common. These methods are adaptable to custom work or low-to-medium production volumes. The key in any lamination process is the precise ratio of resin to reinforcement for each fabric type – the glass-to-resin ratio. Too much resin for a given amount of reinforcement will produce a heavier, more expensive, and more brittle laminate, while too little resin for a given fabric will produce a “dry” and weaker laminate. Some production processes combine techniques, such as when the resin-transfer process is assisted by the use of vacuum. This is the “vacuum-assisted resin-transfer molding process” mentioned above. The combination makes it much easier to achieve the right proportion of glass to resin every time.

The difference between open molding and closed molding is in how the resin is cured. When the resin is exposed to the atmosphere during the cure, it is referred to as open molding. When the resin is not exposed to the atmosphere during cure, it is referred to as closed molding.

E.1 OPEN MOLDING

A single mold that produces a one-sided finish is an open mold. Tooling cost for open molds is relatively low, making it possible to use this technique for short production runs.

Generally a male pattern or model is built, from which a female mold is fabricated. A number of materials can be used to construct molds depending on the shape and quantity of the desired part.

The surface of the mold is prepared with a wax or release agent which allows the part to separate from the mold at the end of the lamination. The longevity of a mold varies and may be a significant cost factor depending on part complexity, material, and cycle time.

E.1.1 HAND LAY UP

Hand lay up refers to the consolidation of the resin fibers using hand tools such as brushes, rollers, and squeegees. The equipment required for hand lay up simply consists of a mold and hand tools. High-quality parts can be manufactured in this process. The ultimate quality depends upon the skill of the laminators, specifically with regard to the dispensing of the amount of resin and the ratio of resin to reinforcement.

The materials commonly used in hand lay up consist of thermoset resins in combination with chopped strand mat, textile fabric, woven or knitted reinforcements, and sometimes a structural core.

The process is accomplished by first applying a cosmetic surface such as gelcoat to the properly prepared mold. Next, the pattern-cut glass reinforcement is placed in the mold and impregnated with the proper amount of resin. The resin can be applied by brush or paint roller from containers of initiated resin or from a spray gun which combines the resin and catalyst in the precise proportion. Once the glass reinforcement is fully saturated or “wet out,” the laminate is compacted with specially designed rollers and brushes to remove air bubbles and distribute the resin evenly.

Multiple layers, or plies, of laminate are built up in sequence, often with a core material in the middle, to reach the desired thickness. Various inserts, ribs, fasteners, or other items can be incorporated in the molded part. Following a curing cycle, the part is de-molded and trimmed as required.

APPENDIX E ■ Fabrication Processes**E.1.2 SPRAY UP**

The spray-up process differs from the hand lay-up method in the way the materials are applied to the mold. Spray up utilizes a chopper gun which sprays catalyzed resin and chopped glass fibers simultaneously. The multi-end roving is fed to the chopper gun from a creel that contains several thousand feet of gun roving.

This multi-end roving is cut or chopped by the action of the spray gun into strands ½ inch (12mm) to 1 ½ inches (36mm) in length and combined with a spray of resin immediately in front of the gun nozzle. The saturated glass/resin matrix is then deposited on the mold surface. Multiple passes build the laminate to the specified thickness. As in the hand lay-up process, consolidation by hand rolling is required to compact the laminate and remove entrapped air. Also as with hand lay up, the ratio of glass fiber to resin is critical. However, spray up, by using only chopped strand mat in the process with no higher strength woven or knitted fabric, produces a heavier, “resin rich” laminate with lower physical properties. If the part is primarily cosmetic, this can be quite acceptable.

Spray up can be faster than hand lay up in some instances, especially in the case of complicated shapes. However, the process does have a greater dependency on operator skill than hand layup, as the laminate deposition is a function of the spray operator.

E.2 CLOSED MOLDING

Closed molding may be considered for two cases: first, if a two-sided finish is needed; and second, if high production volumes are required. Because a mold set now consists of two (or more) molds and more sophisticated processing equipment, the capital investment and tooling cost is greater as compared to open molding. However, the cost per unit produced may be considerably lower if volumes are sufficient. Compression molding, matched metal die molding, resin-injection, and resin-transfer molding are a few terms used to describe the various types of closed molding processes. Generally closed molds are not employed in architectural FRP products because of limited production volume. However, with increased regulation of volatile organic compounds (VOCs) as well as the perfection of vacuum-infusion processing in other industries, closed- molding processes are increasingly available to the architectural market, with a resulting improvement or enhancement of consistency and physical properties. However, in cases where filler is added to resins, such as for fire resistance, vacuum infusion is more difficult, and depending on the desired results, may not be an option.

E.3 PRESS MOLDING

Press molding is a compression-molding process and is the most common method of molding thermosetting materials such as SMC (sheet molding compound), BMC (bulk molding compound), and LCM (liquid composites molding). This molding technique involves compressing materials, specifically resin and fiber reinforcements containing a temperature-activated catalyst in a heated matched metal die using a vertical press. The molding process begins with the delivery to the mold of high viscosity, uncured composites material such as SMC, BMC, or a mat or preform covered with a medium-viscosity resin paste (LCM). Mold temperatures typically range from 300° to 320° F. As the mold closes, the composite’s viscosity is reduced under heat and pressure approximating 1000 psi. The resin and the reinforcements flow to fill the mold cavity in the case of SMC and BMC. With LCM the reinforcements do not move; only the resin paste flows throughout the mold.

APPENDIX E ■ Fabrication Processes

While the mold remains closed, the thermosetting material undergoes a chemical change (cure) that permanently hardens the shape in the mold cavity. Mold closure times vary from 30 seconds to several minutes, depending on part design and material formulation. When the mold opens, parts are ready for finishing operations such as de-flashing, painting, bonding, and installation of inserts for fasteners. By varying the formulation of the thermoset material and the reinforcements, parts can be molded to meet applications ranging from automotive Class 'A' exterior body panels to structural members.

E.4 PULTRUSION

Pultrusion is a continuous molding process that combines fiber reinforcements and thermosetting resin. The pultrusion process is used in the fabrication of composites parts that have a constant cross-sectional profile. Typical examples include various rods, bars, and hollow tube sections, ladder side rails, tool handles, electrical cable tray components, and recently, bridge beams and decks. Most pultruded laminates are formed using single-end rovings aligned with the major axis of the part. Various continuous filament mats, fabrics (braided, woven, and knitted), and texturized or bulk rovings are used to obtain strength in the cross-axis or transverse direction.

The process is normally continuous and highly automated. Reinforcement materials, such as roving, mat, or fabrics, are positioned in a specific location using preforming shapers or guides to form the profile. The reinforcements are drawn through a resin bath or wet-out where the material is thoroughly coated or impregnated with a liquid thermosetting resin. The resin-saturated reinforcements enter a heated metal pultrusion die. The dimensions and shape of the die will define the finished part being fabricated. Inside the metal die, heat is transferred to the reinforcements and liquid resin via precise temperature controls. The heat energy activates the curing or free radical polymerization of the thermoset resin, changing it from a liquid to a solid. The solid laminate emerges from the pultrusion die in the exact shape of the die cavity. The laminate hardens when cooled, and it is continuously pulled through the pultrusion machine and cut to the desired length. The process is driven by a system of caterpillar or tandem (reciprocating hydraulic) pullers located between the die exit and the cut-off mechanism.

E.5 VACUUM INFUSION

Vacuum infusion typically utilizes a mold similar to the one used in hand lay up, but differs in that the reinforcement is placed into the mold dry, covered with an air-tight plastic or rubber bag, and upon removing air from under the bag with a vacuum pump, the resin is allowed to “bleed” or infuse into the dry fabric to create the composites. There are several advantages to this process and some disadvantages. Advantages include higher strength-to-weight ratio, lower resin content, predictable fiber-to-resin ratio and therefore potentially more efficient resin consumption, lower emissions, and the ability to complete complex multi-layer laminates with cores and inserts in a single step rather than as individual layers. Disadvantages include higher labor cost, an increase in consumable materials, and the need for specialized technical skills as compared to hand- or spray-lay-up techniques. Another disadvantage of vacuum infusion is that it is far more difficult to achieve with filled resins, which are frequently required in construction for building code compliance.

E.6 LIGHT RTM

Light RTM (Resin Transfer Molding) is similar to vacuum infusion but utilizes a rigid mold on both surfaces. This improves cycle times since the plastic or rubber bag often takes many hours to “set up”. The double rigid molds also provide the potential for a finish being molded in on both surfaces of a part. Otherwise, similar advantages and disadvantages hold for the two techniques, although the rigid “vacuum bag” is typically more costly to manufacture.

APPENDIX E ■ Fabrication Processes**E.7 VACUUM BAGGING**

Vacuum bagging is typically used on very high performance composites parts when reinforcements are “pre-impregnated” with resin to produce extremely accurate fiber-to-resin ratios. Once the fibers are wet with resin, cut to shape, and placed into the open mold, a vacuum bag is placed over the uncured composites. The air is then removed, and atmospheric pressure is used to consolidate the laminate and reduce the void content as well as the excess resin. Usually this technique is only used to achieve very high strength laminates. Under the proper circumstances, it can produce parts whose properties and quality exceed those possible with even vacuum infusion, although the two techniques increasingly overlap.

E.8 CONTINUOUS LAMINATION

Continuous lamination, as the name suggests, involves introducing resin into a reinforcement. The impregnated reinforcement is then guided through pressing and guiding rolls until the desired composite lay-up is formed. The result is a continuous process which is typically used to create sheet composites such as those for translucent skylights. Similar techniques are used to create very large or very long cored laminates of continuous thickness and dimension. These composites products are rarely an end product in themselves and frequently become a part of an assembly such as a wall or roof panel system.

E.9 CASTING

FRP composites are occasionally cast-formed to achieve full round or double-sided components, usually to meet small size and fairly low strength requirements compared to standard composite laminates. Short fibers are typically mixed into a slurry of resin and fillers and the material poured or pumped into a closed mold. This method has the advantage of creating seamless solid objects and is frequently faster than the more labor intensive lamination processes. The part, however, is typically not as strong or light as similar parts made from closed- or open-mold processes. Balusters are a good example of a product where cast composites can be more cost effective than hand-laminated products.

E.10 ROTATIONAL MOLDING

Rotational molding is casting a quantity of material less than the mold volume into a closed mold which is then rotated to coat the surfaces until the resin sets. This has the advantage of creating a hollow part while retaining the seamless characteristics of a casting. Some architectural columns are made via the rotational molding process as are some containers. Quality control is challenging since the thickness of the casting is difficult to predict and can vary from place to place.

[RETURN TO TEXT: Fabrication Processes](#)

APPENDIX F

Test Methods

APPENDIX F ■ Test Methods

TABLE F.1-1: List of Composites Test Methods

Mechanical properties	Method
Bearing Load	ASTM D1602
Compressive Strength and Modulus	ASTM D695 ASTM D6641 ASTM D3410 ASTM C365 ISO 844
Tensile Strength	ASTM D638 ASTM D3039 ASTM D5083 ASTM C297 DIN 53455
Tensile Modulus	ASTM D638 ASTM D3039 ASTM C297 DIN 53457
% Elongation	ASTM D638 ASTM D3039 ISO 1922
Flexural Strength and Modulus	ASTM D790 ASTM D6272
Flexural Strength and Stiffness	ASTM C393 ASTM D7249 ASTM D7250
Punch Shear Test	ASTM D732
In-plane Shear Strength and Modulus	ASTM D3518 ASTM D3846 ASTM D3914 ASTM D5379 ASTM D4255 ASTM D7078 ASTM C273 ASTM C393 ISO 1922
Lap Shear Strength	ASTM D3164
Short Beam Strength	ASTM D2344
Izod Impact	ASTM D256
Charpy Impact	ASTM D256
Bearing Strength	ASTM D953 ASTM D5961

Fire	Method
Surface Burning Characteristics	ASTM E84 ASTM D162
Oxygen Index	ASTM D2863
NBS Smoke Test	ASTM E662
Multi-Story Building Test	NFPA 285
Room Corner Test	NFPA 286
Ignitability by Radiant Panel	NFPA 268
Potential Heat of Building Materials	NFPA 259
Cone Calorimeter	ASTM E1354

Surface Testing	Method
Gravelometer	SAE J-400
Gardner Gloss Meter	Gardner
Stain Resistance	ANSI Z124
Barcol Hardness	ASTM D2583

Physical Properties	Method
Specific Gravity	ASTM D792
Water Absorption	ASTM D570
Glass Transition	ASTM D7028
CTE	ASTM E289
Heat Distortion	ASTM D648

Material Properties	Method
Brookfield Viscosity	ASTM D2196
Ignition Loss of Cured Reinforced Resins	ASTM D2584
Gel Time	ASTM D2471
Glass Fiber Strands	ASTM D578

[RETURN TO TEXT: Characteristics of FRP](#)

APPENDIX G

CSI Guide Specifications

APPENDIX G ■ CSI Guide Specifications

COMPOSITES FABRICATIONS

Guide Specifications for Fiber-Reinforced-Polymer Composites
American Composites Manufacturers Association (ACMA)

(Specifier Note: The purpose of this guide specification language is to assist the specifier in correctly specifying fiber-reinforced-polymer-composites products and their installation. The specifier needs to edit these guide specifications to fit the needs of each specific project. For assistance in correctly specifying FRP composites, contact ACMA at www.acmanet.org 703-525-0511.

The term Architect is used throughout these guide specifications, but may be replaced by “Design Professional”, “Engineer”, “Owner”, or other appropriate designation as required for the specific project.

*Specifier Notes in italicized red text are included to provide assistance in selecting appropriate text for inclusion in a Specification. **Bold text** indicates that a selection is required. Text in brackets [] presents recommendations that may not be the only options available but are recommended or common selections.)*

(Specifier Note: The indicated section number and title are in accordance with Level 2 MasterFormat numbering. The design professional may elect to make user modifications to the number and title based on the specific project.

This guide specification is focused on composite materials that are identified in the industry as Fiber Reinforced Polymer; FRP; Composites; FRP Composites, and sometimes Fiberglass-Reinforced Composites.)

SECTION 06 80 00 – COMPOSITE FABRICATIONS

PART 1 – GENERAL

1.1 SECTION INCLUDES

- A. **[Delegated Design of] [Interior] [Exterior]** Fiber-Reinforced-Polymer Composites **[Panel Profiles] [Components] [Facades]**.
- B. Accessories

1.2 REFERENCES

- A. Abbreviations:
 - 1. FRP: Fiber-Reinforced-Polymer (FRP) composites.
- B. Reference Standards:

(Specifier Note: The CSI Construction Specifications Practice Guide recommends the inclusion of the date of the reference standard. In lieu of the inclusion of the date herein, the specifier may include the following statement in Division 01, Section 01 42 00 - References: “The date of the standard is that in effect as of the date of receipt of bids for the project.”)

- 1. ASTM International (ASTM)
 - a. ASTM A27 – Standard Test Method for Steel Castings, Carbon, for General Application.
 - b. ASTM A36 – Standard Specification for Carbon Structural Steel.

APPENDIX G ■ CSI Guide Specifications

- c. ASTM A47 – Standard Specification for Ferritic Malleable Iron Castings.
 - d. ASTM A283 – Standard Specification for Low and Intermediate Tensile Strength Carbon Steel Plates.
 - e. ASTM A307 – Standard Specification for Carbon Steel Bolts and Studs, 60,000 PSI Tensile Strength.
 - f. ASTM A325 – Standard Specification for Structural Bolts, Steel, Heat-Treated, 120/105 ksi Minimum Tensile Strength.
 - g. ASTM A580 – Standard Specification for Stainless Steel Wire.
 - h. ASTM A666 – Standard Specification for Annealed or Cold-Worked Austenitic Stainless Steel Sheet, Strip, Plate, and Flat Bar.
2. International Building Code (IBC), **[2009] [2012]**

1.3 ADMINISTRATIVE REQUIREMENTS

- A. Pre-installation Meeting:
 - 1. Convene a pre-installation meeting prior to commencing installation.
 - 2. Require attendance of parties directly affected by the work of this Section of the project.
 - 3. Review conditions of installation, installation procedures, and coordination required with related work.

1.4 SUBMITTALS

(Specifier Note: DELETE Submittal Procedures paragraph when not required. Coordinate requirements with Division 01, Section 01 33 00 – Submittal Procedures.)

- A. Refer to Section **[01 33 00 Submittal Procedures] [insert section number and title]**.
- B. Product Data: Submit standard FRP composites product data.
- C. Shop Drawings: Drawings shall indicate the following:
 - 1. Fabrication shapes and dimensions.
 - 2. Surface finish.
 - 3. Color.
 - 4. Thicknesses.
 - 5. List of part numbers.
 - 6. Anchoring details.
 - 7. Methods of support.
 - 8. Connections between fabrications and adjacent building components.
 - 9. Fabrication details.
 - 10. Required clearances.
 - 11. Lifting and erection details.
 - 12. Allowances for FRP composites fabrication and adjacent material tolerances.

APPENDIX G ■ CSI Guide Specifications

- D. Samples: Submit **[two] [insert number]** samples of each color, minimum 12 inch by 12 inch, showing allowable range of color, **[in specified color, texture, and finish.] [Match sample provided by Architect.]**
- E. Certificates:
1. Manufacturer's qualification statement.
 2. Installer's qualification statement.
 3. Current valid third-party product Listing and Labeling in accordance with the requirements in the **[2009] [2012]** International Building Code. Labels affixed to products manufactured and delivered to the jobsite.
 4. List of manufacturers' personnel with current valid certification in the American Composites Manufacturers Association – Certified Composites Technician program.
- F. Quality Control Program: Manufacturers' internal Quality Control Manual and Quality Assurance Procedures.

(Specifier Note: When the design of the FRP composites products, profiles, or facades requires engineering that has not been provided by the Project Engineer, SPECIFY Delegated Design so that the contractor becomes responsible for the engineering solution to accomplish the design intent. DELETE the requirement for a Delegated-Design Submittal when engineered solution is not required.)

- G. Delegated-Design Submittal: For FRP composites assemblies indicated to comply with performance requirements and design criteria, include analysis data and calculations signed and sealed by the licensed professional engineer responsible for their preparation.
- H. Manufacturer's Instructions: Submit manufacturer's printed installation instructions, maintenance instructions, and recommendations for product delivery, storage, and handling.
- I. Closeout Submittals:

(Specifier Note: DELETE Closeout Submittal paragraph when not required. Coordinate requirements with Division 01, Section 01 78 00 – Closeout Submittals.)

1. Refer to Section **[01 78 00 Closeout Submittals] [Insert section number and title]**.
2. Submit manufacturer's warranty for project.

1.5 QUALITY ASSURANCE

- A. Qualifications:
1. Manufacturer:
 - a. Shall provide products manufactured by a firm specializing in the fabrication of FRP composites products with a minimum of five years' experience.
 - b. Shall **[be a member of the American Composites Manufacturers Association (ACMA)] [and] [have a Certified Composites Technician (CCT) on staff]**.

(Specifier Note: Manufacturer as part of the Listing and Labeling Program will have an internal quality-control program. Requirement of both the Listing and Labeling Program and the quality-control program sets a quality standard.)

- c. Shall have a Listing and Labeling program indicating compliance with flame-spread index requirements per Section 2012, **[2009] [2012]** IBC.
- d. Shall have an internal quality-control program.

APPENDIX G ■ CSI Guide Specifications

2. Installer:
 - a. Shall be approved by the manufacturer for the installation of components provided under this Section.
 - b. Shall have a minimum of five years' experience in the successful installation of FRP composites for projects of comparable size.
3. Welders: Shall be qualified by the American Welding Society "Standard Qualification Procedure" for arc or gas welding of connecting structures.

(Specifier Note: DELETE one of two Mock-up paragraphs depending on project requirements. Coordinate requirements with Division 01, Section 01 40 00 – Quality Requirements. Samples indicated in submittals are for color selection. Representative Samples may not be exact components due to associated cost, but will be representative of the product to be provided.)

Mock-ups (Representative Sample): Build mock-ups to verify selections made under Sample submittals and to demonstrate aesthetic effects and set quality standards for materials and execution. Refer to Section **[01 40 00 Quality Requirements]**. **[Insert section number and title]**.

Provide **[in-place]** **[off-site]** mockups of typical exterior components as indicated on Drawings.

OR

Mock-ups: Refer to Section **[01 40 00 Quality Requirements]**; **[insert section number and title]**.

1.6 DELIVERY, STORAGE, AND HANDLING

(Specifier Note: DELETE Product Requirement paragraph when not required. Coordinate requirements with Division 01, Section 01 60 00 – Product Requirements.)

- A. Refer to Section **[01 60 00 Product Requirements]**; **[insert section number and title]**.
- B. Transport, handle, and store FRP composites products according to manufacturer's recommendations and in a manner that prevents cosmetic and structural damage.
- C. Inspect each component to ensure that it complies with specified requirements.
- D. Verify that areas where panels will be unloaded are clear of obstructions and well-drained.
- E. Brace and stabilize FRP composites products to prevent warping.
- F. Protect FRP composites products from damage by retaining shipping protection in place until installation.

(Specifier Note: If a 5-year warranty is not required, units will be subject to the general construction warranty. Verify that manufacturer offers a 5-year warranty on the project-specific units.)

1.7 WARRANTY

- A. Warrant FRP composites products to be free from defects due to materials and workmanship for **[one year]** **[five years]**.

APPENDIX G ■ CSI Guide Specifications

PART 2 – PRODUCTS

(Specifier Note: For assistance in correctly specifying FRP composites, contact ACMA at www.acmanet.org 703-525-0511.)

2.1 MATERIALS

A. Molded Exterior Surface:

1. Coating: **[UV-inhibited in-mold coating] [paint] [adhesive film]**.
2. Texture and Color: **[As selected from manufacturer's color line] [Match architect's sample]**.

B. Laminate:

1. Matrix:

(Specifier Note: Unsaturated polyester resin is the most common type of resin used in FRP composites products, Consult with FRP manufacturer to verify the appropriate resin to use based on project requirements.)

- a. Resin: Unsaturated **[polyester] [vinyl ester] [epoxy] [urethane] [phenolic]**.
- b. Fillers and Additives: As required.
2. Fiber Reinforcement:

(Specifier Note: E-glass fiber is the most common fiber type used in FRP composites products. Consult with FRP manufacturer to verify the appropriate fiber type is specified, based on project requirements.)

- a. Fiber Type: **[E-glass fiber] [Carbon fiber] [Natural fiber] [Insert fiber]**.
- b. Fiber Architecture:

(Specifier Note: Verify with manufacturer. Fiber architecture shall be based on project requirements. Random chopped is most common. Select orientation of fibers based on manufacturer's recommendation.)

- i. **[Chopped Strand Mat (CSM): random chopped]**.
- ii. **[Oriented-strand glass fibers; [oriented] [multi-axial] [unidirectional]]**.
- iii. **[Woven]**.
- iv. **[Veil]**.
- c. Glass Content (Fiber Volume Fraction):
 - i. Standard: Minimum 25 percent.
 - ii. Filled Systems: Minimum 15 percent.

3. Core:

(Specifier Note: Verify with local codes that building construction type allows the core material selected below; fire code may not allow the use of certain core material.)

- a. Material: **[Balsa] [Foam Core] [Honeycomb] [Plywood] [Other]**.
- b. Density: Per manufacturer's recommendation.

APPENDIX G ■ CSI Guide Specifications

2.2 DESIGN CRITERIA

- A. Engineering calculations shall account for the following loads:
1. Dead Loads: **[Insert load]** psi dead load with deflection limited to **[insert deflection]** of span. **[Include the weight of the FRP-composites components and attached items.]**
 2. Live Loads: **[Insert load]** psi live load with deflection limited to **[insert deflection]** of span. **[As required by applicable code.]**
 3. Wind Loads: **[___ mph winds.] [As required by applicable code. Consider wind loads as an inward pressure and as an outward suction.]**
 4. Snow Loads: **[___ psf snow load.] [As required by applicable codes.]**
 5. Seismic Design Forces: As required by applicable code.
 6. Load Combinations: Consider applicable load combinations. Do not combine wind loads with seismic loads.
- B. Installed products shall be capable of withstanding positive and negative wind pressure without structural failure, cracking, crazing, permanent distortion, or displacement.
- C. Provisions for Movement:
1. Design and detail anchorages, connections, and joints to allow for dimensional changes of the FRP composites product.

(Specifier Note – Exterior Applications: Verify flammability requirements of FRP composites products with IBC 2009 Section 2612.6.or IBC 2012 Section 2612.5.)

- D. FRP Component Fire Test Response Characteristics:

(Specifier Note – Exterior Applications: Verify flammability requirements of FRP-composites products with IBC 2009 Section 2612.6.or IBC 2012 Section 2612.5. Design professional needs to coordinate with AHJ for size limitations and location of use on building for the exterior application of FRP components.)

1. FRP composites used as exterior components shall meet the requirements of IBC Section **[2612.6] [2612.5]** for combustibility.

(Specifier Note – Interior Applications: Confirm project-specific fire classification requirements based on Section 2612.3 of the IBC 2009 and 2012.)

2. FRP composites used as interior finish material shall meet the requirements of IBC Section 2612.3 for combustibility. Products shall be identified with the markings of a recognized testing agency.
 - a. Interior wall and ceiling finish classification: **[Class A] [Class B] [Class C]**.

2.3 FABRICATION

- A. General: Fabricate and finish FRP composites **[panel profiles] [components] [facades]** and accessories at the factory to the greatest extent possible, by manufacturer's standard procedures and processes, as necessary to fulfill indicated performance requirements demonstrated by laboratory testing. Comply with indicated profiles and with dimensional and structural requirements.

APPENDIX G ■ CSI Guide Specifications

- B. Fabricate **[panel profiles] [components] [facades]** in accordance with approved shop drawings.
1. Laminate Thickness: Nominal thickness 3/16 inch.
 2. Embed anchors into **[panel profiles] [components] [facades]** per approved shop drawings.
 3. After removing component from mold, prepare exposed surface for specified finish texture.
 4. Seams and mold lines shall be filled where necessary, ground smooth, and finished to match surrounding surfaces.
 5. Provide major ribs and intermediate stiffening ribs as indicated on approved shop drawings.
 6. Identification:
 - a. Identify each part with a permanent serial number.
 - b. Number parts to coordinate with shop drawings.
 7. Cure and clean components prior to shipment, and remove material that may be incompatible with adjacent building materials.
- C. Finish Texture of exposed surfaces: **[Smooth] [Light sandblast]**.
1. Finish texture shall be consistent and even over exposed surfaces to match approved samples.
- D. Apply coatings to a properly prepared surface in accordance with coating manufacturer's instructions.
1. Integrally molded gelcoat thickness: Minimum 18 mils thick.
- E. Furnish accessories for securing FRP composites **[panel profiles] [components] [facades]** to supporting and adjacent construction.
- F. Fabrication Tolerances:

(Specifier Note: Consult with manufacturer to provide reasonable fabrication tolerances based on the specific project.)

1. Total Thickness: Plus or minus 1/16 inch.
2. Gelcoat Thickness: Minus 2 mils; plus 10 mils.
3. Length: Plus or minus 1/8 inch in 10 feet.
4. Location of Accessories and Other Connecting Hardware: Plus or minus 1/4 inch.
5. Variation from Square: Plus or minus 1/4 inch in 10 feet.
6. Out-of-plane Variation: Plus or minus 1/4 inch in 10 feet.
7. Warping or Bowing: Plus or minus 1/4 inch in 10-square-foot area.

2.4 ACCESSORIES

(Specifier Note: EDIT metal anchors and fastener requirements to suit Project needs.)

- A. Metal Anchors and Fasteners: As recommended by manufacturer and conforming to the following standards:
1. Structural steel: ASTM A36.
 2. Cold drawn wire: ASTM A580, Type 304, Cond. A.
 3. Stainless steel: ASTM A666, Type 304.

APPENDIX G ■ CSI Guide Specifications

4. Carbon steel plate: ASTM A283.
 5. Malleable iron castings: ASTM A47.
 6. Carbon steel castings: ASTM A27, grade 60-30.
 7. Anchor bolts ASTM A307 or ASTM A325.
- B.** Fire Blocking: In compliance with applicable code and as indicated on approved shop drawings; refer to Section **[06 10 00 Rough Carpentry]** **[insert section number and title]**. **[NOTE to JB: Please change the red “B” to black.]**
- C.** Sealant: **[urethane]** **[polyurethane]** **[acrylic]** **[silicone]**.
- D.** Adhesive: As recommended by manufacturer.

PART 3 – EXECUTION

3.1 EXAMINATION

- A. Observe field conditions to confirm that building lines, grades, and elevations will allow proper installation of FRP composites products.
- B. Verify that support framing has been constructed to allow accurate placement and alignment of anchor bolts, plates, dowels, or other connections to structure.
- C. Prior to installation, verify all field dimensions. Report discrepancies that could affect installation. Do not proceed with installation until discrepancies are corrected.
- D. The beginning of installation means the acceptance of existing conditions.

3.2 ERECTION

- A. Install components in accordance with manufacturer’s instructions and approved shop drawings.
- B. Lifting and Positioning: Lift FRP composites with suitable lifting devices at points indicated on approved shop drawings.
- C. Set components level, plumb, square, and true within the allowable tolerances.
- D. Temporarily support and brace panels as required to maintain position, stability, and alignment until permanent connection.
- E. Do not allow components to be cut, trimmed, or otherwise changed without express written permission or direction from the manufacturer. Provide revised calculations and shop drawings in the event a revision is required.
- F. Fastening:
 1. Fasten FRP composites products as shown on approved shop drawings.
 2. Perform arc or gas welding in accordance with FRP-composites manufacturer’s instructions and approved shop drawings, using materials compatible with the base material.

APPENDIX G ■ CSI Guide Specifications

G. Tolerances:

1. Warpage: Maximum permissible warpage of one corner out of the plane of the other three shall be 1/8 inch per foot, or 3/8 inch total after installation.
2. Bowing: Less than $L/200$ with a maximum of 1 where L is the panel length in the direction of the bow. Differential bowing between adjacent members of the same design shall be no more than 1/4 inch.
3. Width of Joint: 1/4 to 3/4 inch, depending upon engineering criteria.
4. Maximum Offset from True Alignment: 1/4 inch in 20 feet.
5. Maximum Variation from True Position: 1/2 inch in 20 feet.
6. Gap Tolerances between Joints for panel dimensions of:
 - a. Less than 10 feet: plus or minus 3/16 inch.
 - b. 10 feet to 20 feet: plus or minus 1/4 inch.
 - c. Greater than 20 feet: plus or minus 5/16 inch.

3.3 CLEANING

- A. Clean installed products using cleaning methods and materials approved by FRP-composites manufacturer.

3.4 PROTECTION

- A. Comply with FRP-composites manufacturer's recommendations and instructions for protecting installed products during construction activities.

END OF SECTION

DISCLAIMER:

Guide Specifications have been written as an aid to the professionally qualified specifier and design professional. The use of this information requires the professional judgment and expertise of the qualified specifier and design professional to adapt the information to the specific needs of the building Owner and the Project; to coordinate with the design professional's construction document process; and to meet the applicable building codes, regulations and laws. ACMA disclaims any warranty, expressed or implied, including the warranty of fitness for a particular purpose of the product for a project.

© 2013 ACMA

RETURN TO TEXT: CSI Guide Specifications

APPENDIX H

Fire Decision Tree for Architects

APPENDIX H ■ Fire Decision Tree for Architects

In order to use the International Building Code (IBC) in a more manageable fashion, we have, with the help of Professor Nicholas Dembsey of the Fire Protection Engineering Department at WPI and Dr. Gert Guldentops of the Architectural Engineering Department at WPI (Worcester Polytechnic Institute), created a flowchart that walks through certain requirements regarding the design and use of exterior assemblies. This document provides brief background information on the International Building Code as well as exterior assemblies in order to make the flowchart useful for all parties.

The International Building Code is a document created by experts in the field of safety and hazards in construction. The most recent version of the building code was produced in 2012 and consists of “code regulations that safeguard the public health and safety in all communities, large and small” (International Building Code, 2012). The building code regulates construction through 35 different sections, each pertaining to a different aspect of the construction process. The sections that this flowchart deals with are Section 14, Exterior Walls, and Section 26, Plastic. Rather than deciphering the International Building Code to determine if a particular external assembly is up to par in regard to construction standards, this flowchart asks the designer a series of questions that go into detail relative to the IBC requirements.

The flowchart focuses on exterior assemblies. There is no one exterior assembly that is standard, but rather there are a multitude of assemblies that can include different materials and different designs, as long as they fit the requirements of the IBC. For example, one external assembly can be completely made of wood, while another can be completely made of Fiber Reinforced Polymer (FRP). Some external assemblies happen to be made of both plastics and wood, but no matter what they are made of, they must meet the requirements of the IBC. The following flowchart allows users to determine if their exterior assembly is acceptable by the IBC standards.

The flowchart contains a series of numbered sections that help the reader understand an assembly and whether or not it is acceptable. Arrows indicating yes or no are connected to the numbered sections and they are to be followed, respectively, depending on if the requirements are met or not. There are two main divisions of the flowchart, one for Type I-IV construction, and one for Type V construction. Section number two will lead the reader to the correct division depending on the construction type. (If the construction type is unknown, Table 503 of the IBC will provide appropriate details for determining construction type). Designers should begin the flowchart process with section number one and continue through the appropriate sections.

The flowchart is color-coded by external assembly type. Sections one through six should be viewed by every designer, regardless of the material. From then on, designers can jump from section to section based on the color that their material represents. A detailed color key can be found later on in this document. Designers should be aware, however, that they must not only read the colored sections pertaining to their material. They must also read any white section that occurs after the colored section that the designer has interest in, because the white section might contain valuable information that pertains to all types of exterior assemblies. From then on, the basics of the flowchart take over and the reader will be directed through to the end by the designation in the numbered sections.

In the flowchart, dotted lines surrounding certain sections represent the separate sections or chapters of the IBC where the enclosed information can be found. Therefore, if you find dotted lines surrounding a set of sections in the flowchart, the corresponding IBC section number (e.g. 2603.5) can be found inside these dotted lines. They are simply in place for reference back to the IBC.

APPENDIX H ■ Fire Decision Tree for Architects**Abbreviations and Definitions of Common Terms****FP = Foam Plastic Insulation***

A plastic that is intentionally expanded by the use of a foaming agent to produce a reduced-density plastic. Such a plastic contains voids consisting of open or closed cells distributed throughout the plastic for thermal insulating or acoustical purposes. It must have a density of less than 20 pounds per cubic foot (pcf) (320 kg/m³).

FRP = Fiber Reinforced Polymer*

A polymeric composite material consisting of reinforcement fibers, such as glass, impregnated with a fiber-binding polymer, which is then molded and hardened. Fiber-reinforced polymers are permitted to contain cores laminated between fiber-reinforced-polymer facings.

FSI = Flame Spread Index*

A comparative measure, expressed as a dimensionless number, derived from visual measurements of the spread of flame versus time for a material tested in accordance with ASTM E 84 or UL 723.

CRS = Corrosion Resistive Steel*

Steel that has the ability to withstand the deterioration of its surface or its properties when exposed to its environment.

ASS = Automatic Sprinkler System*

An automatic sprinkler system, for fire protection purposes, is an integrated system of underground and overhead piping designed in accordance with fire-protection engineering standards.

PVC = Polyvinylchloride**

A synthetic thermoplastic material made by polymerizing vinyl chloride.

PP = Polypropylene**

A plastic polymer used chiefly for molded parts, electrical insulation, packaging, and fibers for wearing apparel.

SDI = Smoke Developing Index

* *Definitions directly from IBC*

** *Definitions from dictionary.com*

APPENDIX H ■ Fire Decision Tree for Architects

Decision Tree

COLOR KEY

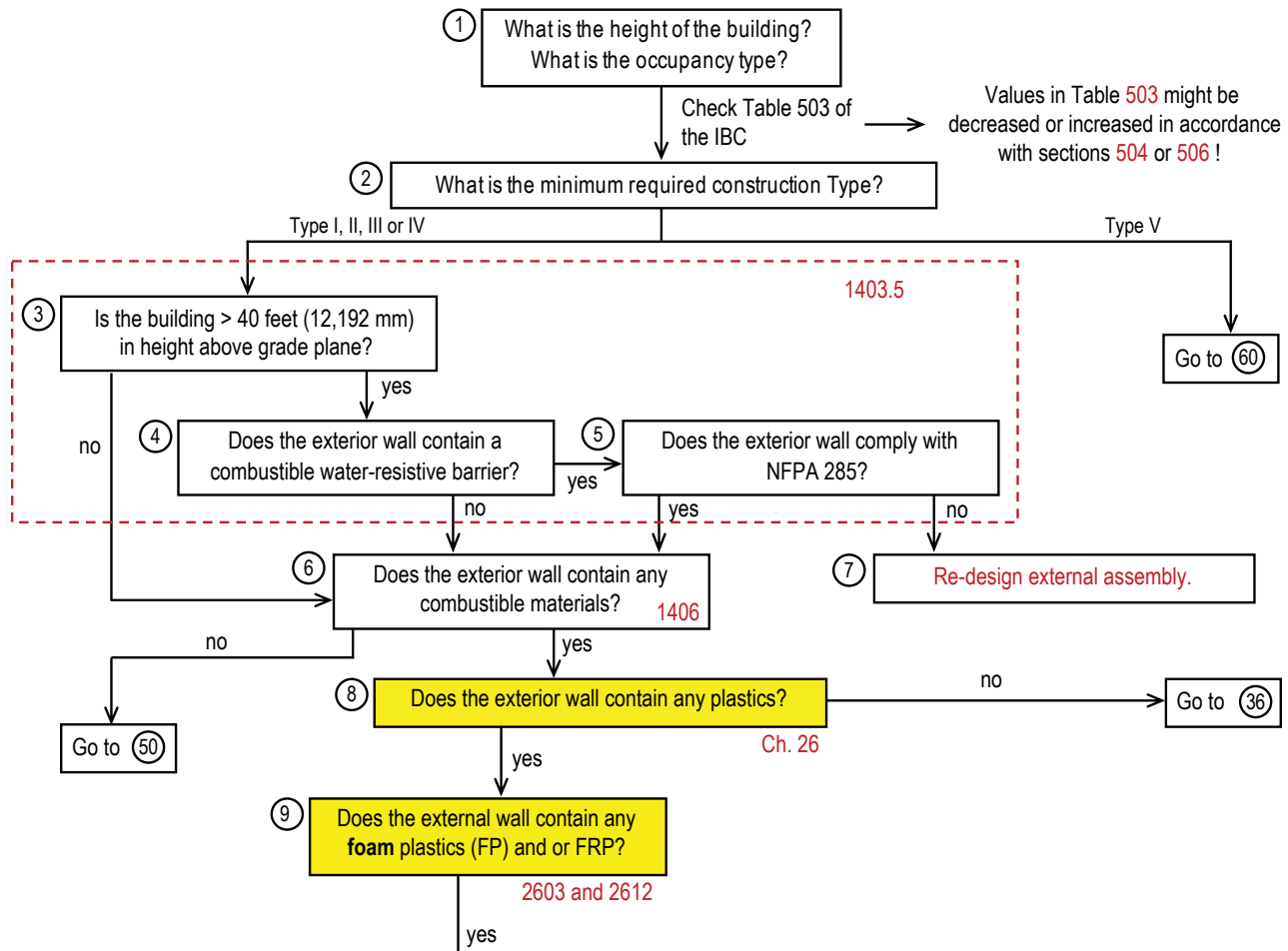
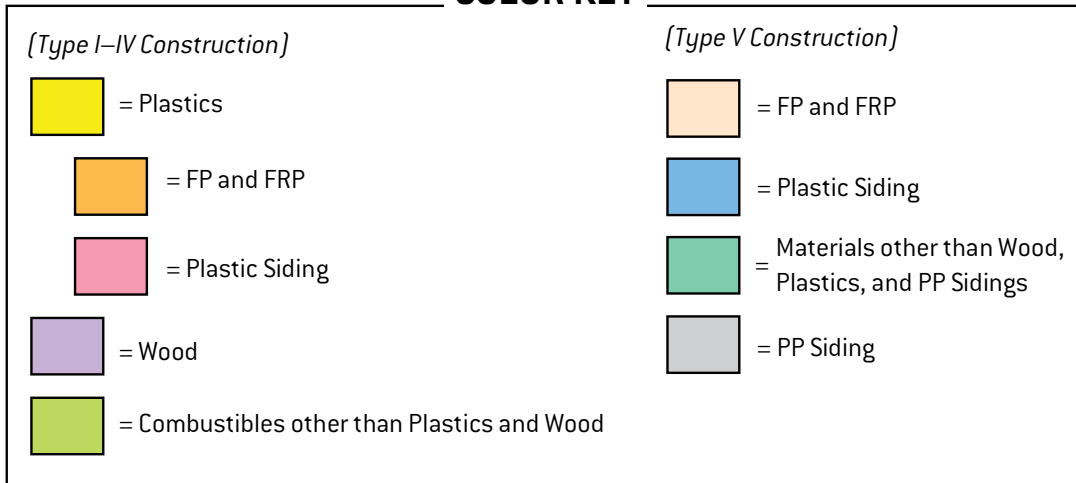

— Continued on next page

APPENDIX H ■ Fire Decision Tree for Architects

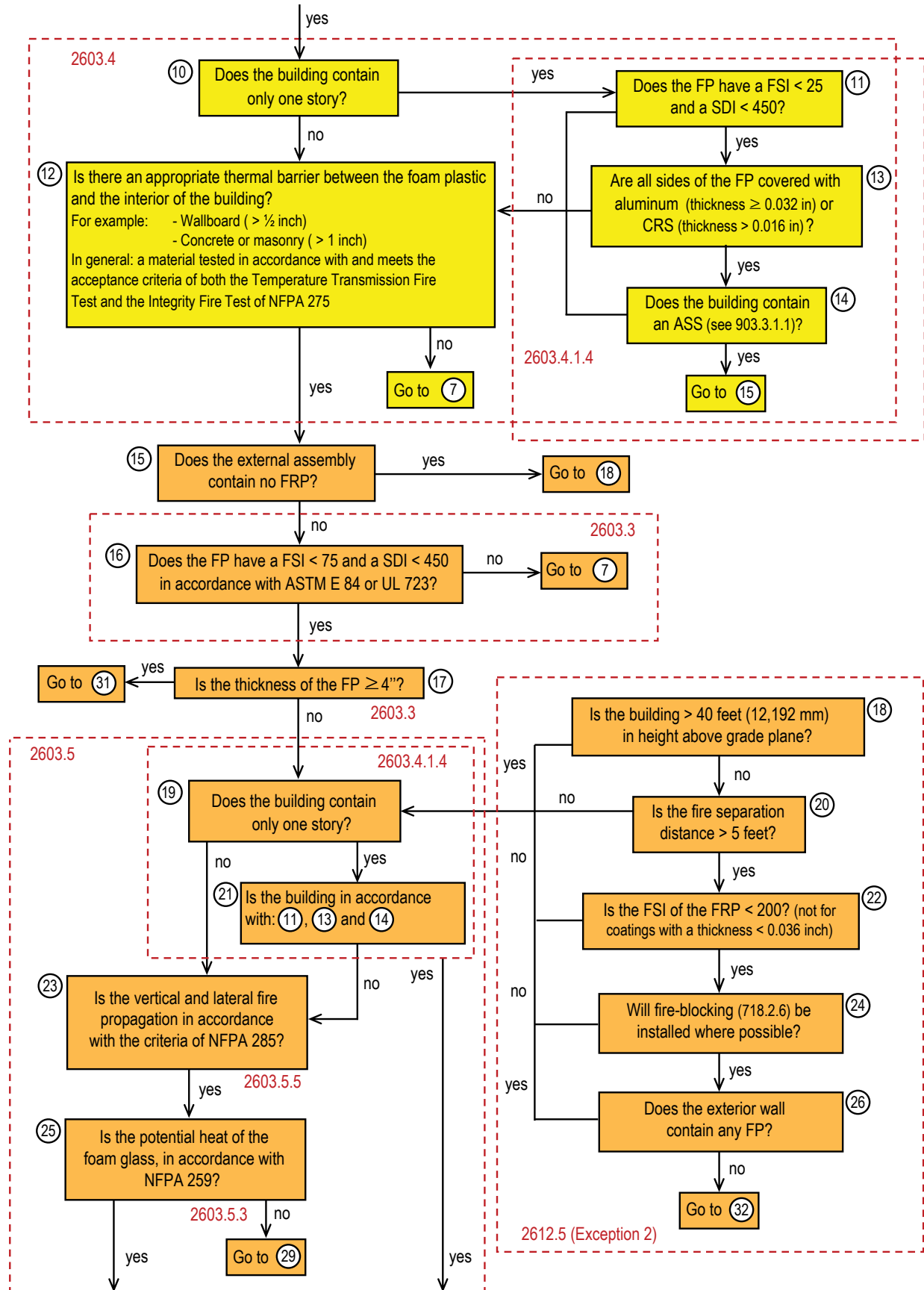

— Continued on next page

APPENDIX H ■ Fire Decision Tree for Architects

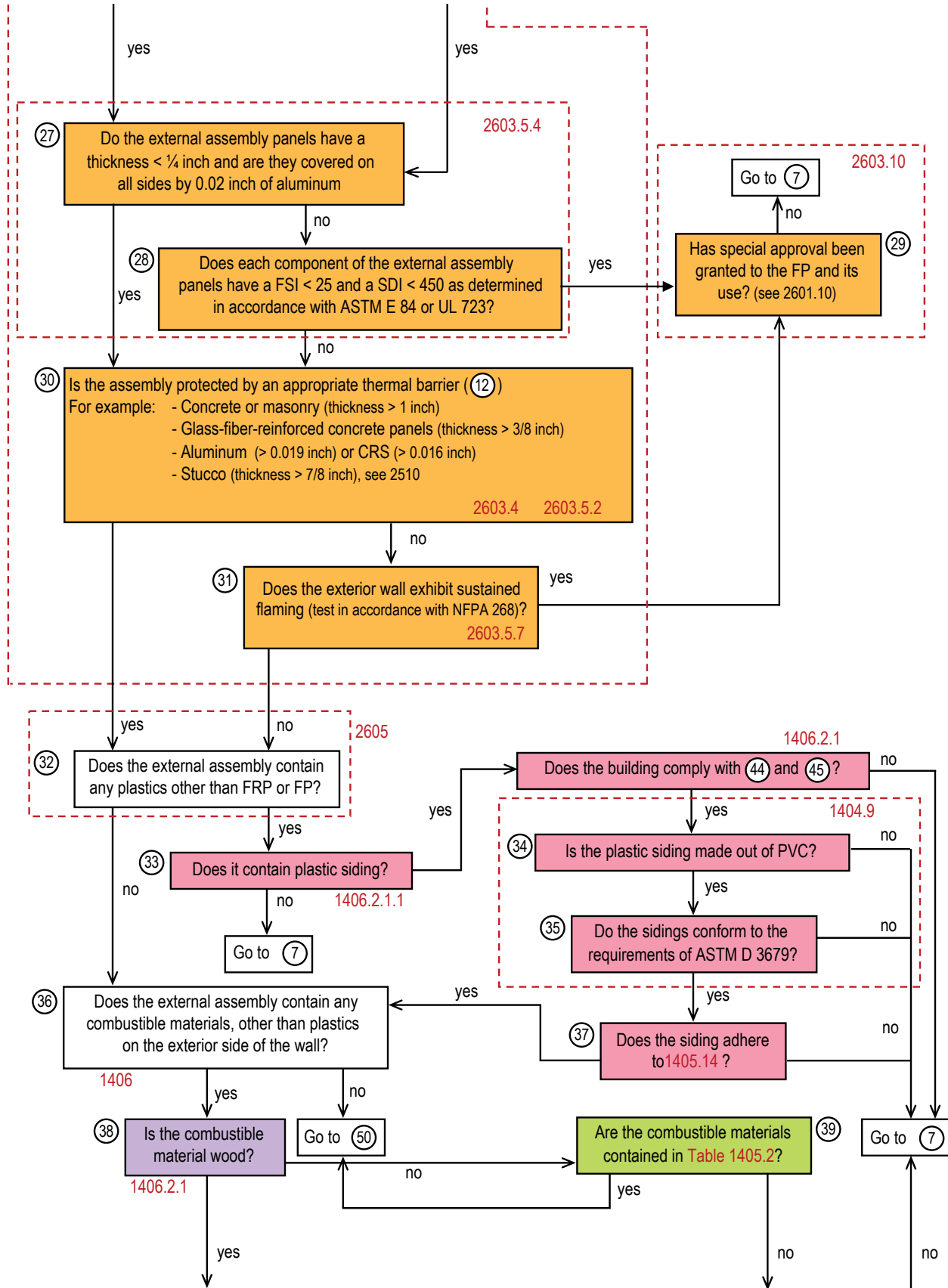

— Continued on next page

APPENDIX H ■ Fire Decision Tree for Architects

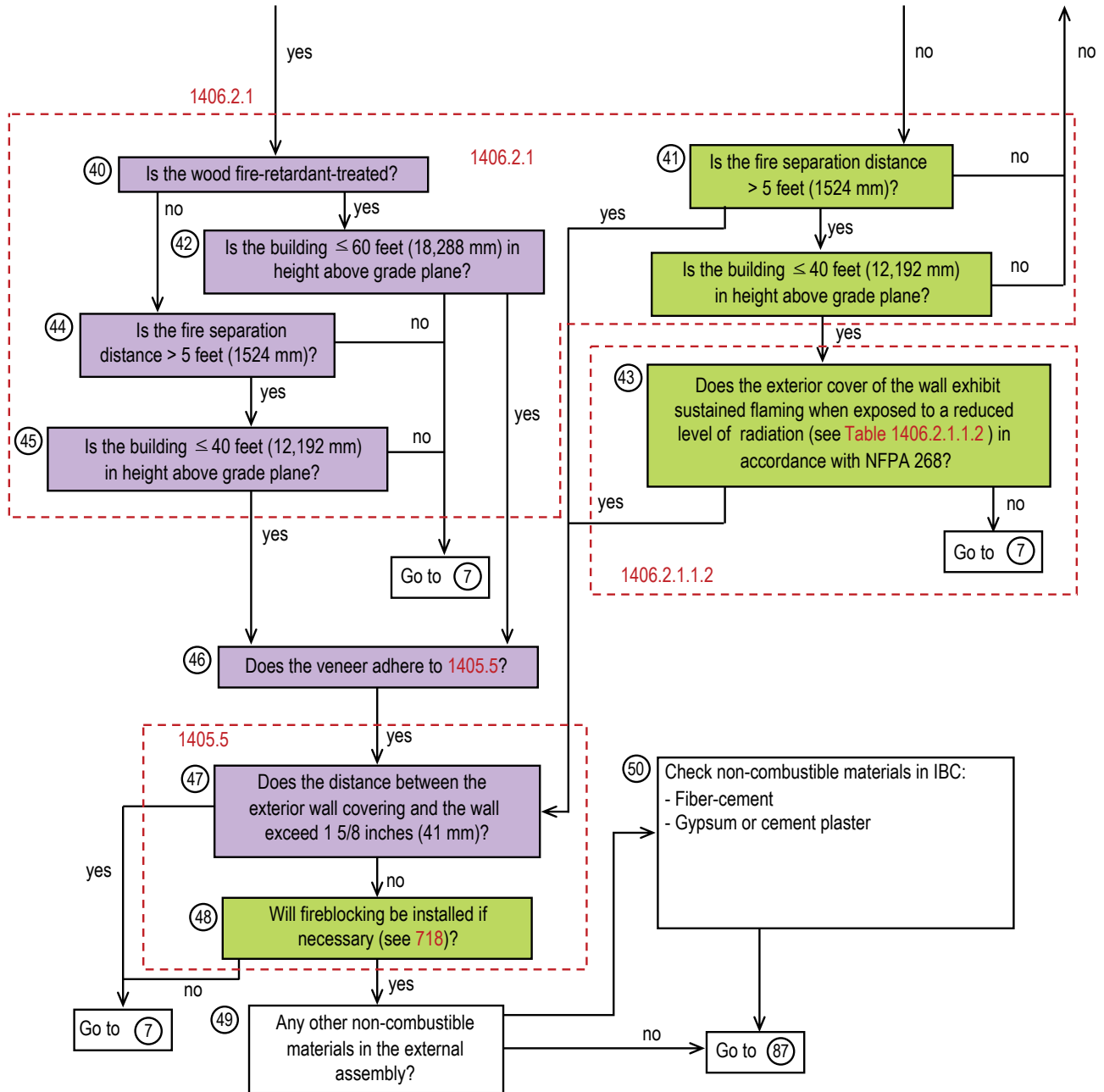

— Continued on next page

APPENDIX H ■ Fire Decision Tree for Architects

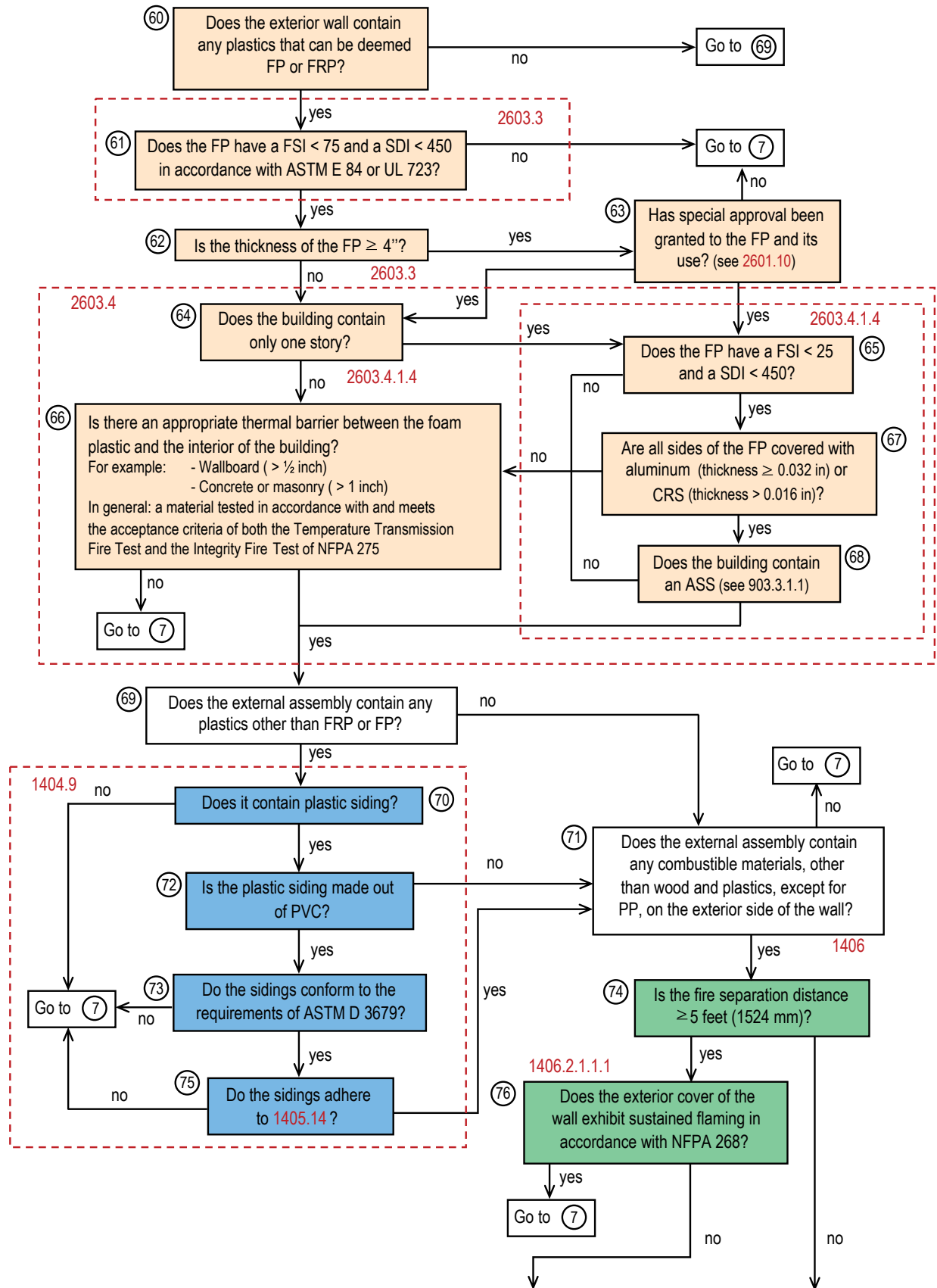

— Continued on next page

APPENDIX H ■ Fire Decision Tree for Architects

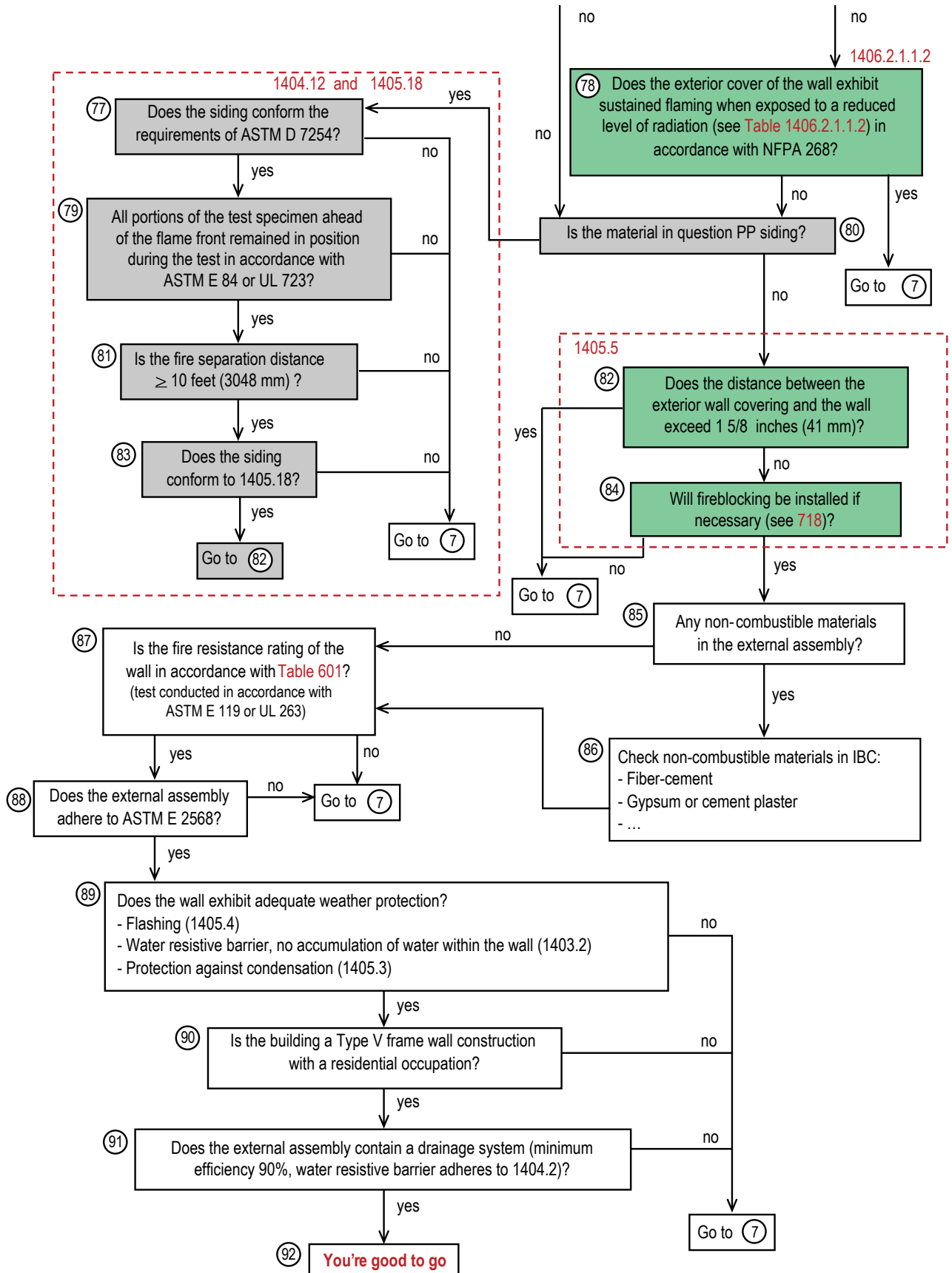

[RETURN TO TEXT: Design](#)

APPENDIX I

Fire Decision Trees for Manufacturers

APPENDIX I ■ Fire Decision Trees for Manufacturers**Flowchart Rationale**

For people not familiar with the International Building Code (IBC), understanding how to navigate its pages can be very difficult. The IBC establishes the minimum regulations for how buildings are to be constructed. Throughout the code there are specifications based on many different things, for example, the height of the building, how it will be used, how it is built, what the building will be made with, and more. Having to deal with such a wide range of factors results in the IBC being very challenging to follow; this is especially true if one does not already have solid knowledge of the building code.

After analyzing another flowchart (developed by Dr. Gert Guldentops, Architectural Engineering, WPI) aimed at simplifying the IBC, the group, in cooperation with Professor Nicholas Dembsey, Fire Protection Engineering, WPI, decided that the best course of action would be to focus on specialized materials used for exterior wall assemblies. The materials that were selected (Foam Plastic Insulation, High-Pressure Decorative Exterior-Grade Compact Laminates, Fiber-Reinforced Polymer, Exterior Insulation and Finish Systems, Metal Composite Material, and Fire-Retardant-Treated Wood) all have distinctive properties that cause them to have unique regulations regarding their usage, as defined in the IBC. While evaluating these different materials, the group noticed that many of them had comparable characteristics and properties.

After exploring ways in which to design the flowchart, the team decided that the properties that overlapped did not provide a solid basis for a singular flowchart which could be used for all of the separate materials. Additionally, referencing the original flowchart, the group agreed that using a different flowchart for each material would provide a much easier to understand and clearer result. While compiling the materials into their own respective flowcharts, the team recognized that many of the materials referenced foam plastic insulation. With the intention of making everything easy to comprehend, the group decided that making a separate flowchart for foam plastic insulation that could be referenced by the other materials would be helpful. If everything checks out, the flowchart ends by saying that the material is approved for the use under consideration. After that, whoever is constructing or designing the building must still pass the usual criteria for the building without having to worry about the unique material restrictions.

While designing the final set of flowcharts, the team also generated a guide whose purpose is to convey how to use the flowcharts. There is also a glossary defining the different types of construction as well as the different abbreviations and the many terms used throughout the flowcharts. The guide has been a fundamental part in the development of a simplified way to use the IBC; without it, understanding the newly designed flowcharts may not be any easier than understanding the old ones.

Using This Report

These flowcharts are designed to make it much easier to use the IBC when designing a building. Many of the complications with the IBC come when trying to use different materials and understand how they each have their own set of rules and guidelines. Based on this, the next section contains flowcharts separated by materials. However, just separating the flowcharts by materials would still create a very complicated set of charts. To reduce confusion, the flowcharts are further separated into subcategories based on different conditions regarding how the materials are to be used. For example, for the use of High-Pressure, Decorative, Exterior-Grade, Compact Laminates, there are very different stipulations for using them at ground level and for using them over forty feet in the air.

The directions and contents of the flowcharts are on the same page, which helps prevent errors from flipping back and forth or using the wrong directions. On the following page, the specific conditions for each different material are listed. These conditions then point to the corresponding flowchart that should be followed in the next section. In addition, there is a glossary describing different materials, building conditions, and common terms from the IBC. The glossary also shows the abbreviations used with many terms.

APPENDIX I ■ Fire Decision Trees for Manufacturers

The different materials appear in the following order: Foam Plastic Insulation (FPI), High-Pressure, Decorative, Exterior-Grade, Compact Laminates (HPL), Fiber-Reinforced Polymer (FRP), Exterior Insulation and Finish Systems (EIFS), Metal Composite Material (MCM), and Fire-Retardant-Treated Wood (FRT). The directions for HPL, FRP, and MCM all contain instructions to also go through the FPI flowchart. After reaching the box that points to FPI, there is no need to go back to that material's flowchart: you can just continue with the FPI chart.

Throughout the flowcharts, many rules state a specific test or standards that the material must pass or meet. Inside the boxes, in parentheses at the end of each box, are the section numbers from the IBC. In contrast, the numbers of the standards and codes are in bold – to show the distinction between the two types of numbers.

Material-Specific Conditions**Foam Plastic Insulation:**

1. Construction Type I-IV – proceed to page 104
2. Construction Type V – proceed to page 105

High-Pressure, Decorative, Exterior-Grade, Compact Laminates:

1. Construction Type I-IV – proceed to page 106
2. Construction Type V – proceed to page 106
3. Installations up to 40 feet in height – proceed to page 107
4. Installations up to 50 feet in height – proceed to page 107

Fiber-Reinforced-Polymer Conditions:

1. Construction Type I-V – proceed to page 108
2. Exception 1 – proceed to page 108
3. Exception 2 (Installed on buildings up to 40 feet above the grade) – proceed to page 109

Exterior Insulation and Finish Systems:

1. No specific conditions – proceed to page 110

Metal-Composite Material Conditions:

1. Construction Type I-IV – proceed to page 111
2. Construction Type V – proceed to page 111
3. Installations up to 40 feet in height – proceed to page 112
4. Installations up to 50 feet in height – proceed to page 112
5. Installations up to 75 feet in height, Option 1 – proceed to page 113
6. Installations up to 75 feet in height, Option 2 – proceed to page 113
7. Installations over 75 feet – proceed to page 113

Fire-Retardant-Treated Wood:

1. No specific conditions – proceed to page 114

APPENDIX I ■ Fire Decision Trees for Manufacturers

Glossary

Construction Types from IBC Chapter 6:

Type I and Type II

Types I and II construction are those in which the building elements listed in Table 601 are of noncombustible materials, except as permitted in Section 603 and elsewhere in this code.

Type III

In Type III construction, the exterior walls are of noncombustible materials and the interior building elements are of any material permitted by this code. Fire-retardant-treated wood framing complying with Section 2303.2 shall be permitted within exterior wall assemblies of a 2-hour rating or less.

Type IV

Type IV construction (Heavy Timber, HT) has exterior walls of noncombustible materials and interior building elements of solid or laminated wood without concealed spaces. The details of Type IV construction shall comply with the provisions of this section. Fire-retardant-treated wood framing complying with Section 2303.2 shall be permitted within exterior wall assemblies with a 2-hour rating or less. Minimum solid-sawn nominal dimensions are required for structures built using Type IV construction (HT). For glued laminated members, the equivalent net finished width and depths corresponding to the minimum nominal width and depths of solid-sawn lumber are required as specified in Table 602.4.

Type V

In Type V construction, the structural elements, exterior walls, and interior walls are of any materials permitted by this code.

Abbreviations and Definitions from IBC Chapter 2:

Automatic Sprinkler System = ASS

An automatic sprinkler system for fire protection is an integrated system of underground and overhead piping designed in accordance with fire-protection engineering standards. The system includes a suitable water supply. The portion of the system above the ground is a network of specially sized or hydraulically designed piping installed in a structure or area, generally overhead, and to which automatic sprinklers are connected in a systematic pattern. The system is usually activated by heat from a fire and discharges water over the fire area.

Exterior Insulation and Finish Systems = EIFS

EIFS are nonstructural, non-load-bearing, exterior-wall-cladding systems that consist of an insulation board attached either adhesively or mechanically, or both, to the substrate; an integrally reinforced base coat; and a textured protective finish coat.

Fiber-Reinforced Polymer = FRP

A polymeric composite material consisting of reinforcement fibers, such as those made of glass, impregnated with a fiber-binding polymer, which is then molded and hardened. Fiber-reinforced polymers are permitted to contain cores laminated between fiber-reinforced-polymer facings.

Fire-Resistance Rating

The rating depends on the period of time a building element, component, or assembly maintains the ability to confine a fire, or continues to perform a given structural function, or both, as determined by the tests, or the methods based on the tests, prescribed in Section 703.

APPENDIX I ■ Fire Decision Trees for Manufacturers**Fire-Retardant-Treated Wood = FRT**

Pressure-treated lumber and plywood that exhibit reduced surface-burning characteristics and resist fire propagation.

Fire Separation Distance = FSD

The distance measured from the building face to one of the following:

1. The closest interior lot line.
2. The centerline of a street, an alley, or a public way.
3. An imaginary line between two buildings on the property.

The distance shall be measured at right angles to the face of the wall.

Flame Spread Index = FSI

A comparative measure, expressed as a dimensionless number, derived from visual measurements of the spread of flame versus time, for a material tested in accordance with ASTM E 84 or UL 723.

Foam Plastic Insulation = FPI

A plastic that is intentionally expanded by the use of a foaming agent to produce a reduced-density plastic containing voids which consist of open or closed cells distributed throughout the plastic for thermal insulating or acoustical purposes. The plastic must have a density of less than 20 pounds per cubic foot (pcf) (320 kg/m³).

High-Pressure, Decorative, Exterior-Grade, Compact Laminates = HPL

Panels consisting of layers of cellulose fibrous material impregnated with thermosetting resins and bonded together by a high-pressure process to form a homogeneous nonporous core suitable for exterior use.

Metal Composite Material = MCM

A factory-manufactured panel consisting of metal skins bonded to both faces of a plastic core.

Smoke Developing Index = SDI

A comparative measure, expressed as a dimensionless number, derived from measurements of smoke obscuration versus time, for a material tested in accordance with ASTM E 84 or UL 723.

APPENDIX I ■ Fire Decision Trees for Manufacturers

Foam Plastic Insulation – Flowchart 1

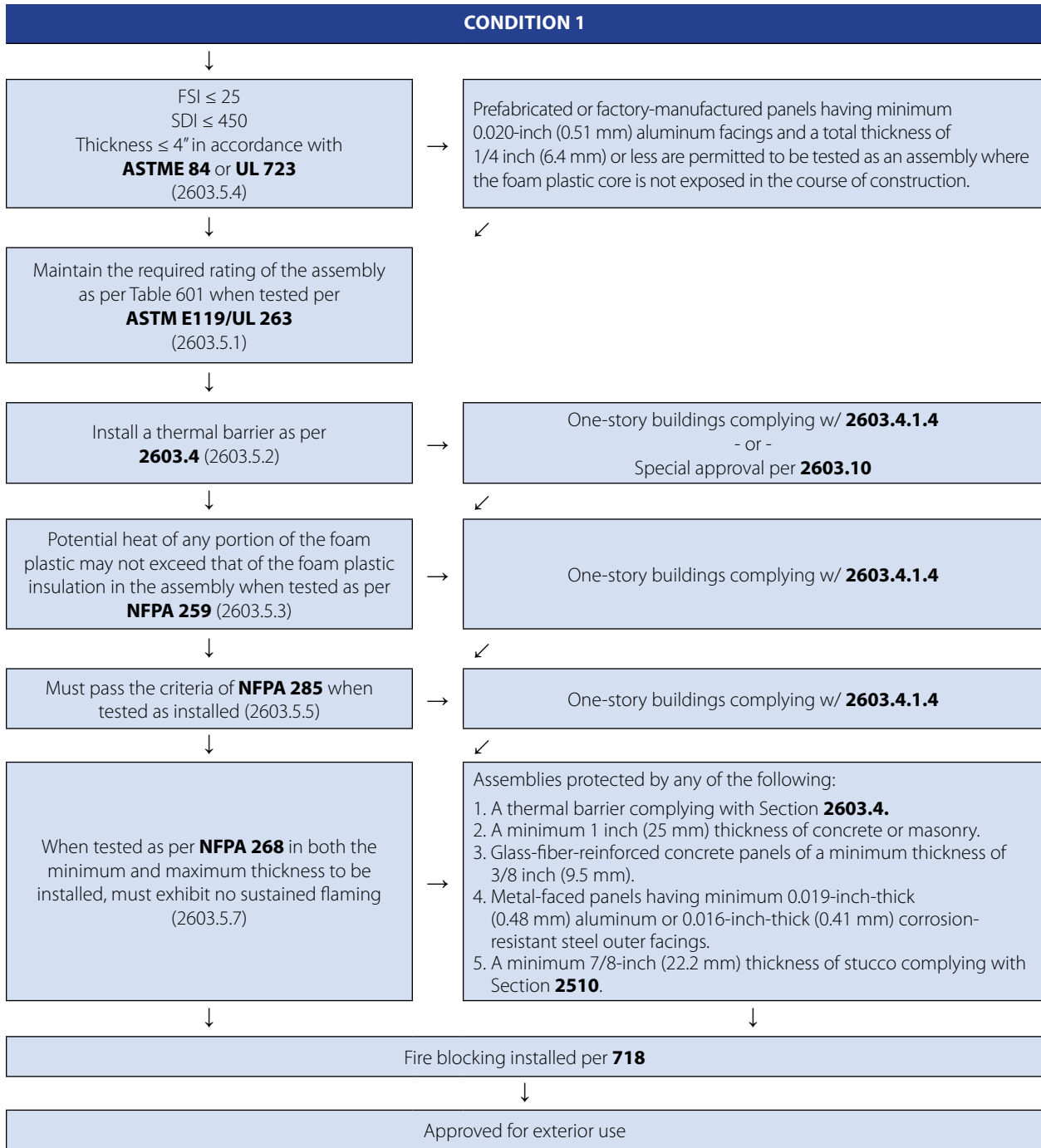

How to use the FPI Flowchart 1:

1. If the criteria in the box are met, follow the ↓ symbol down.
2. If the criteria in the box are met, follow the ✓ symbol to the box down and to the left.
3. If the criteria in the box are not met, then follow the → symbol to the right.
4. If the criteria in the box are not met and there are no symbols, then that construction is not permitted.

APPENDIX I ▪ Fire Decision Trees for Manufacturers

Foam Plastic Insulation – Flowchart 2

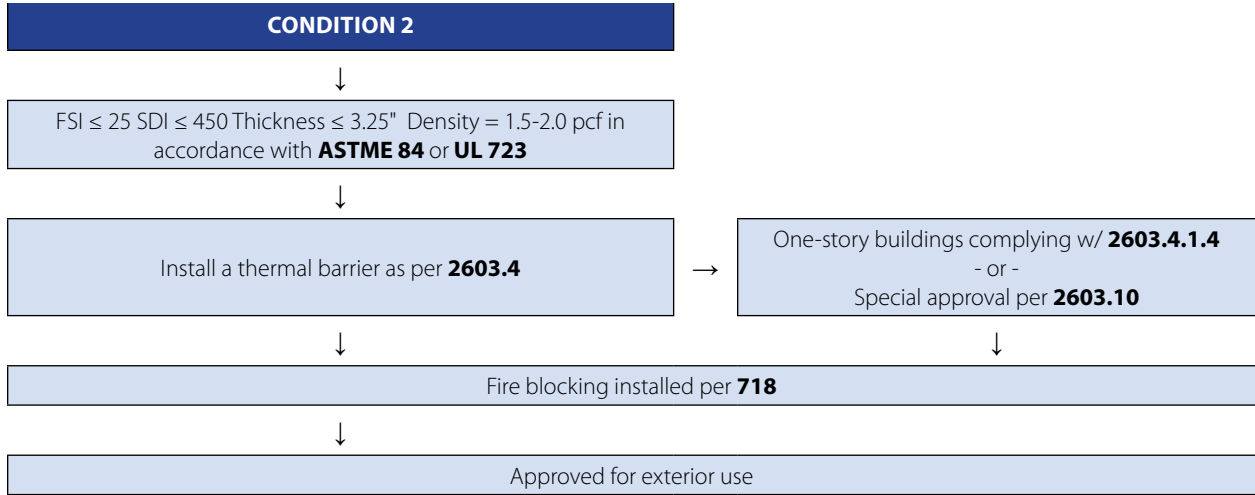

How to use the FPI Flowchart 2:

1. If the criteria in the box are met, follow the ↓ symbol down.
2. If the criteria in the box are not met, then follow the → symbol to the right.
3. If the criteria in the box are not met and there are no symbols, then that construction is not permitted.

APPENDIX I ▪ Fire Decision Trees for Manufacturers

High-Pressure Decorative Exterior-Grade Compact Laminates – Flowchart 1

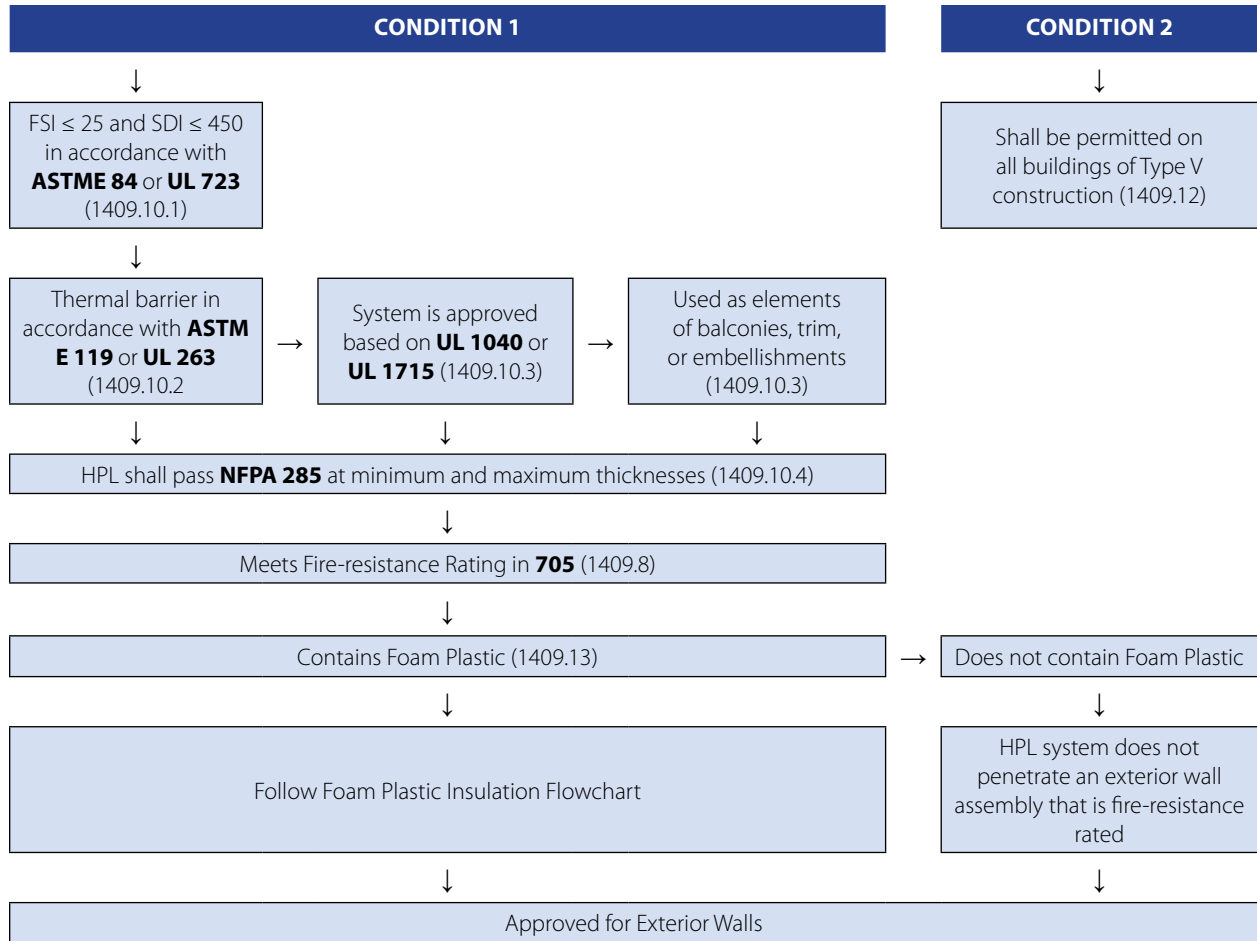

How to use the HPL Flowchart 1:

1. If the criteria in the box are met, follow the ↓ symbol down.
2. If the criteria in the box are not met, then follow the → symbol to the right.
3. If the criteria in the box are not met and there are no symbols, then that construction is not permitted.

APPENDIX I ▪ Fire Decision Trees for Manufacturers

High-Pressure Decorative Exterior-Grade Compact Laminates – Flowchart 2

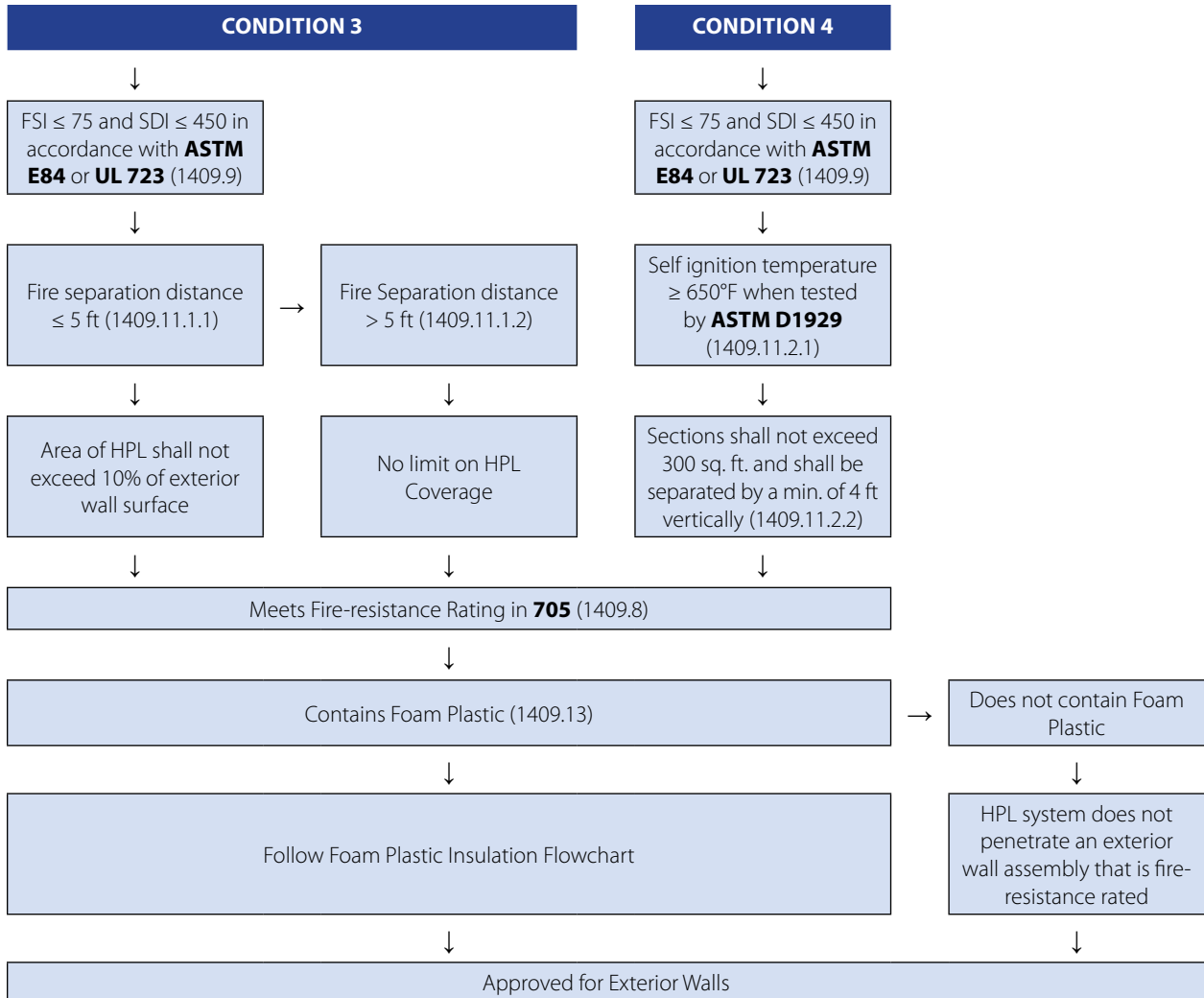

How to use the HPL Flowchart 2:

1. If the criteria in the box are met, follow the ↓ symbol down.
2. If the criteria in the box are not met, then follow the → symbol to the right.
3. If the criteria in the box are not met and there are no symbols, then that construction is not permitted.

APPENDIX I ▪ Fire Decision Trees for Manufacturers

Fiber-Reinforced Polymer – Flowchart 1

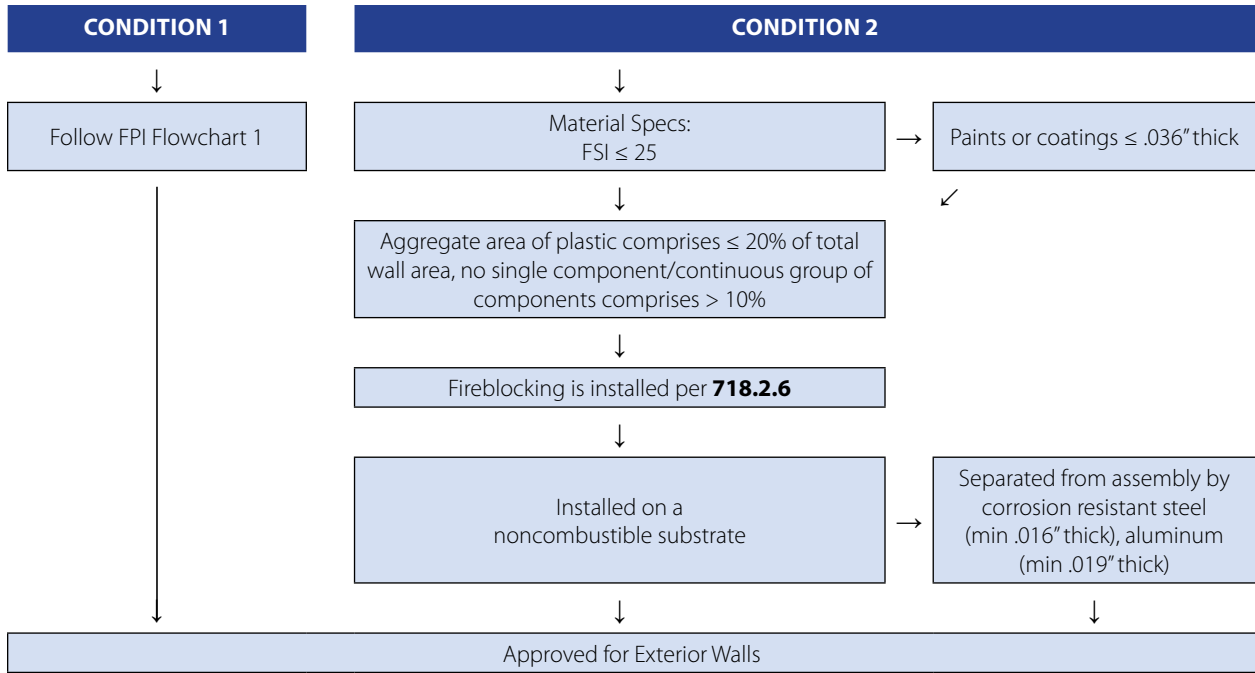

How to use the FRP Flowchart 1:

1. If the criteria in the box are met, follow the ↓ symbol down.
2. If the criteria in the box are met, follow the ↙ symbol to the box down and to the left.
3. If the criteria in the box are not met, then follow the → symbol to the right.
4. If the criteria in the box are not met and there are no symbols, then that construction is not permitted.

APPENDIX I ■ Fire Decision Trees for Manufacturers

Fiber-Reinforced Polymer – Flowchart 2

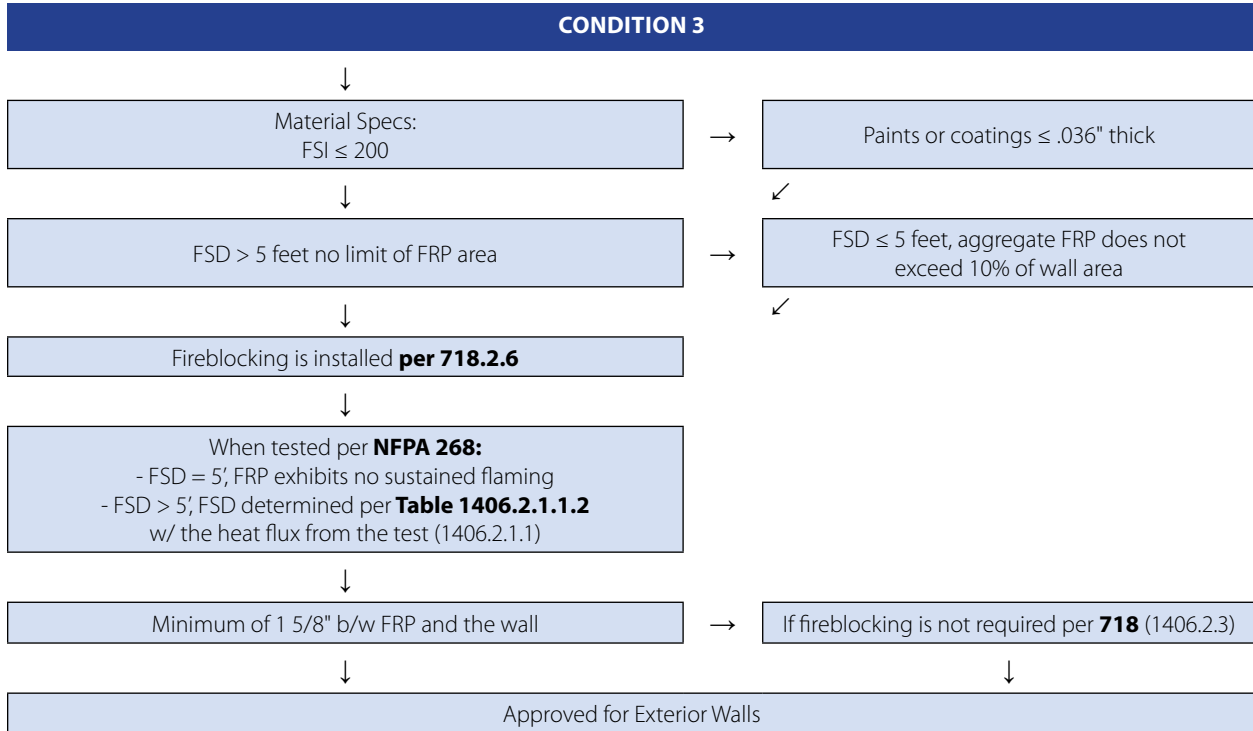

How to use the FRP Flowchart 2:

1. If the criteria in the box are met, follow the ↓ symbol down.
2. If the criteria in the box are met, follow the ↙ symbol to the box down and to the left.
3. If the criteria in the box are not met, then follow the → symbol to the right.
4. If the criteria in the box are not met and there are no symbols, then that construction is not permitted.

APPENDIX I ▪ Fire Decision Trees for Manufacturers

Exterior Insulation and Finish Systems – Flowchart 1

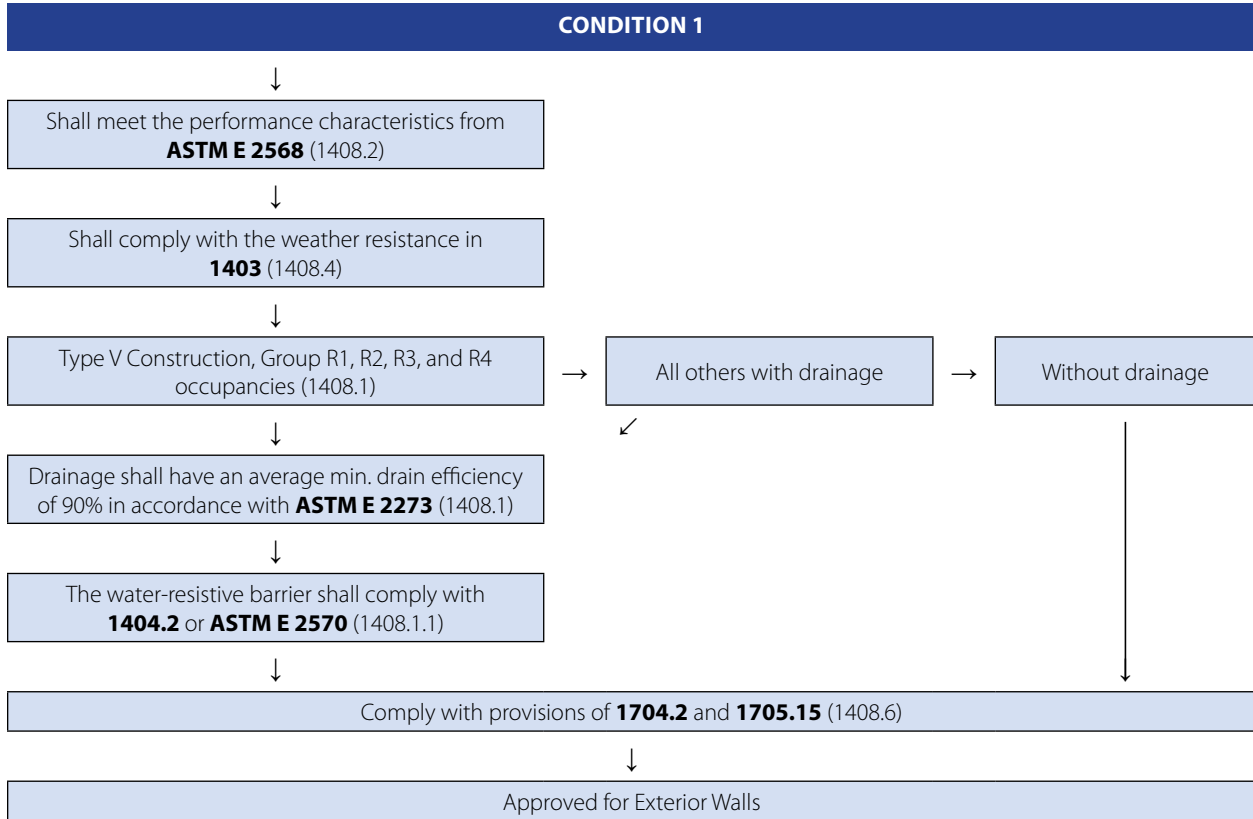

How to use the EIFS Flowchart 1:

1. If the criteria in the box are met, follow the ↓ symbol down.
2. If the criteria in the box are met, follow the ↙ symbol to the box down and to the left.
3. If the criteria in the box are not met, then follow the → symbol to the right.
4. If the criteria in the box are not met and there are no symbols, then that construction is not permitted.

APPENDIX I ▪ Fire Decision Trees for Manufacturers

Metal Composite Material – Flowchart 1

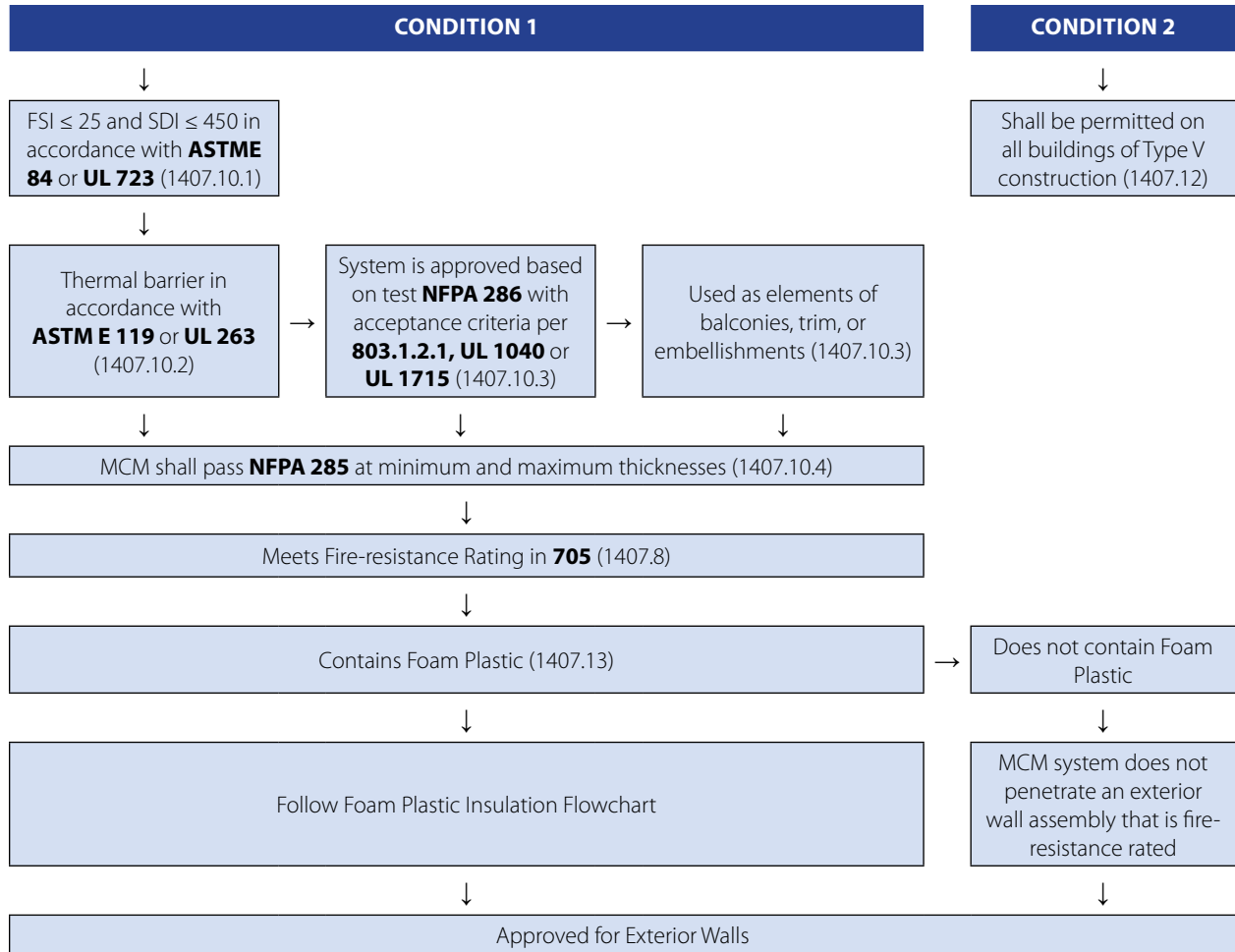

How to use the MCM Flowchart 1:

1. If the criteria in the box are met, follow the ↓ symbol down.
2. If the criteria in the box are not met, then follow the → symbol to the right.
3. If the criteria in the box are not met and there are no symbols, then that construction is not permitted.

APPENDIX I ■ Fire Decision Trees for Manufacturers

Metal Composite Material – Flowchart 2

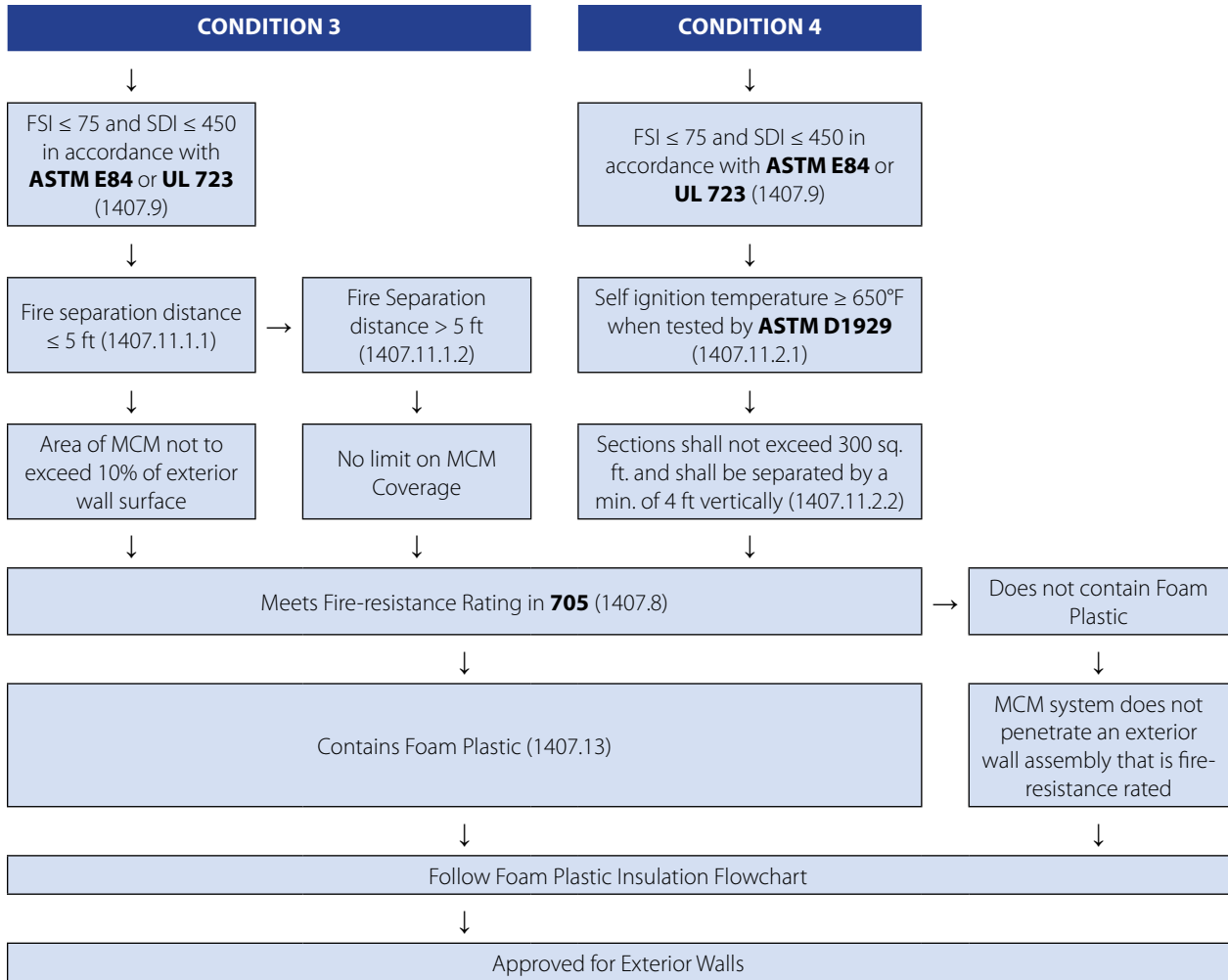

How to use the MCM Flowchart 2:

1. If the criteria in the box are met, follow the ↓ symbol down.
2. If the criteria in the box are not met, then follow the → symbol to the right.
3. If the criteria in the box are not met and there are no symbols, then that construction is not permitted.

APPENDIX I ■ Fire Decision Trees for Manufacturers

Metal Composite Material – Flowchart 3

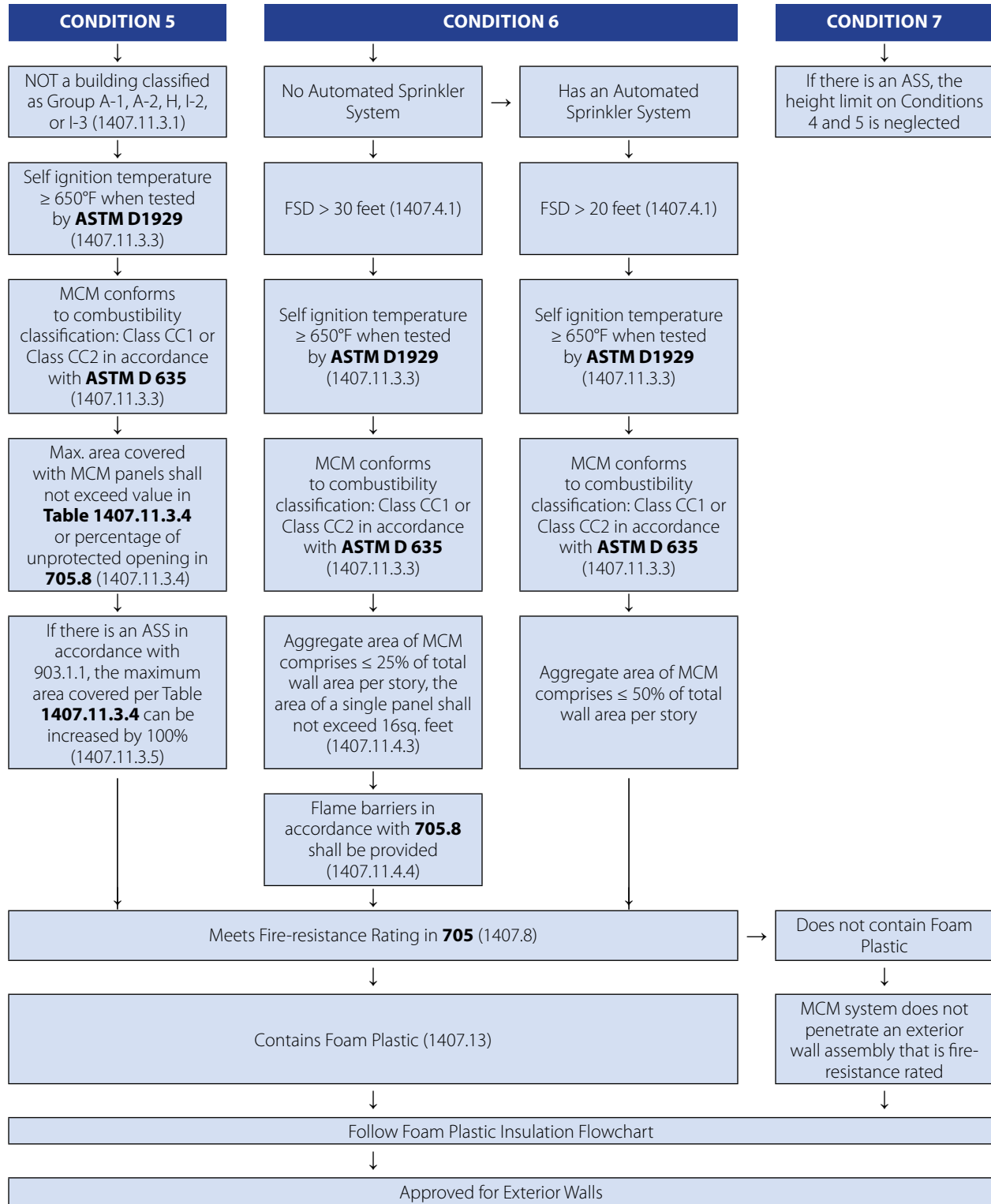

How to use the MCM Flowchart 3:

1. If the criteria in the box are met, follow the ↓ symbol down.
2. If the criteria in the box are not met, then follow the → symbol to the right.
3. If the criteria in the box are not met and there are no symbols, then that construction is not permitted.

APPENDIX I ▪ Fire Decision Trees for Manufacturers

Fire-Retardant Treated Wood – Flowchart 1

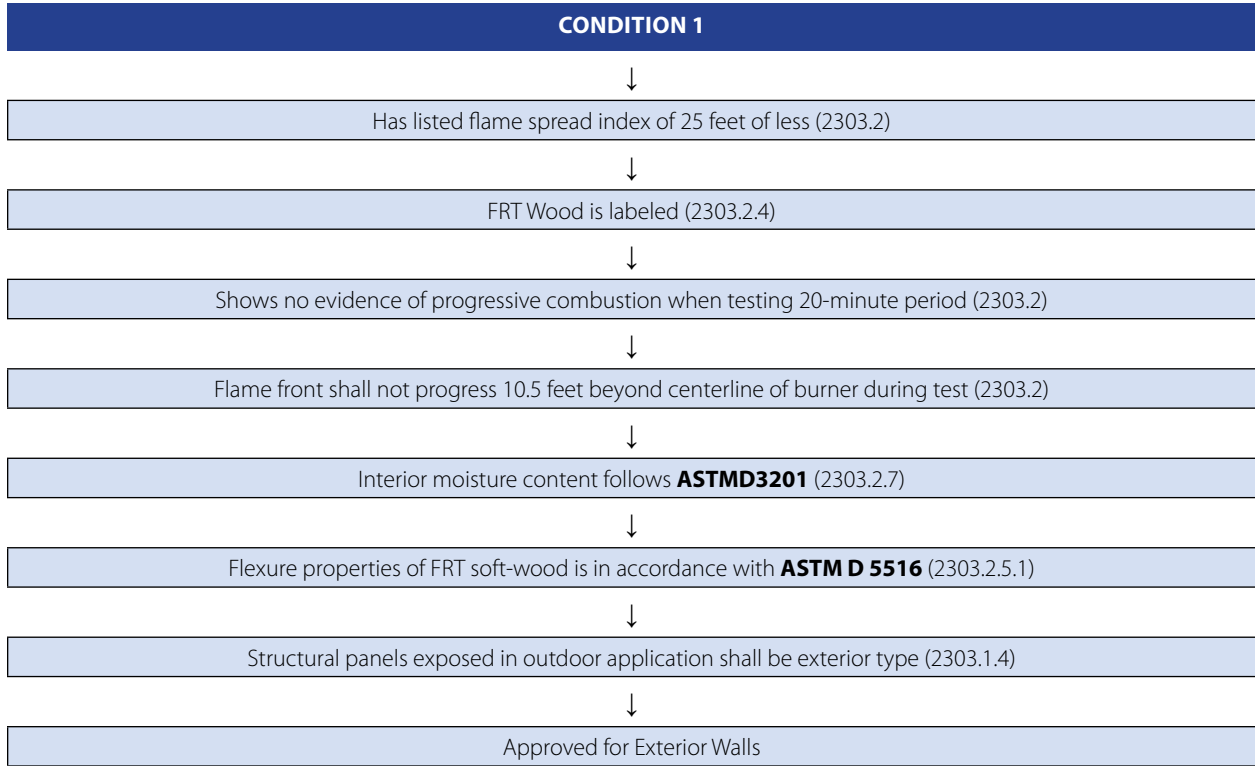

How to use the FRT Flowchart 1:

1. If the criteria in the box are met follow the ↓ symbol down
2. If the criteria in the box are not met then follow the → symbol to the right
3. If the criteria in the box are not met and there are no symbols then that construction is not permitted

[RETURN TO TEXT: Design](#)

APPENDIX J

Engineering Design Guide

APPENDIX J ■ Engineering Design Guide**J.1 RAW MATERIALS**

Common technical properties of fibers include specific gravity, density, tensile strength, elongation to failure, and elastic modulus. Published values are available, as are common fiber architectures (geometries). The fiber type most commonly used in architectural FRP components is glass fibers, with carbon fibers used occasionally for additional strength or stiffness. The ASTM D578 Standard Section #4 provides guidance regarding glass fiber types, along with chemical composition of the E-glass and E-CR-glass fiber.

Resin selection should consider adhesion to fibers, mechanical properties including allowable strain, durability, and toughness, as well as project-specific building code requirements such as smoke and fire performance. Manufacturing techniques may affect resin choice and cured resin properties. Further information regarding fiber and resins can be found in [APPENDIX D: FRP Composites Raw Materials](#).

Once a fiber, fiber architecture, and resin are selected and analyzed as individual laminas, an FRP composite designer should consider laminate strains, stresses, deformations, connection details, member curvature, and stiffeners (if required) for subsequent designs and analysis. Thus the fiber, fiber architecture, and resin information will be incorporated in the actual laminate analysis.

J.2 GENERAL FRP COMPOSITES DESIGN CONSIDERATIONS

Individual layers (laminas) of FRP composite materials are not isotropic nor necessarily anisotropic. An individual layer will respond as an orthotropic material, having dominant material properties along a preferred direction (fiber direction) and lesser properties transverse to that direction, provided that the applied stresses align, or are transverse, to the fiber direction. Thus if there is one preferred direction, such as the fiber direction, then the layer is transversely isotropic. For such a case, the in-plane stress-strain relations can be found from four independent elastic constants: E_x , E_y , ν_{xy} , and G_{xy} (Agarwal and Broutman, 1990). For an isotropic material such as mild steel, only two independent constants are required to define the stress-strain state within a lamina.

Individual layers are often stacked to create a laminate that, like individual laminas, will have different material properties in three perpendicular directions such as the x, y, and z directions shown in Figure J.2-1 for a laminate of thickness “t”. Classical lamination theory (CLT) (Jones, 1999) can be used to determine the strength and stiffness along the two in-plane directions, such as the x and y directions in Figure J.2-1. Excluding certain unique fiber weaves which may contain a relatively large amount of fibers in the “z”, or thickness, direction, most thickness- direction strength and stiffness properties of FRP laminates can be estimated from the resin properties.

APPENDIX J ■ Engineering Design Guide

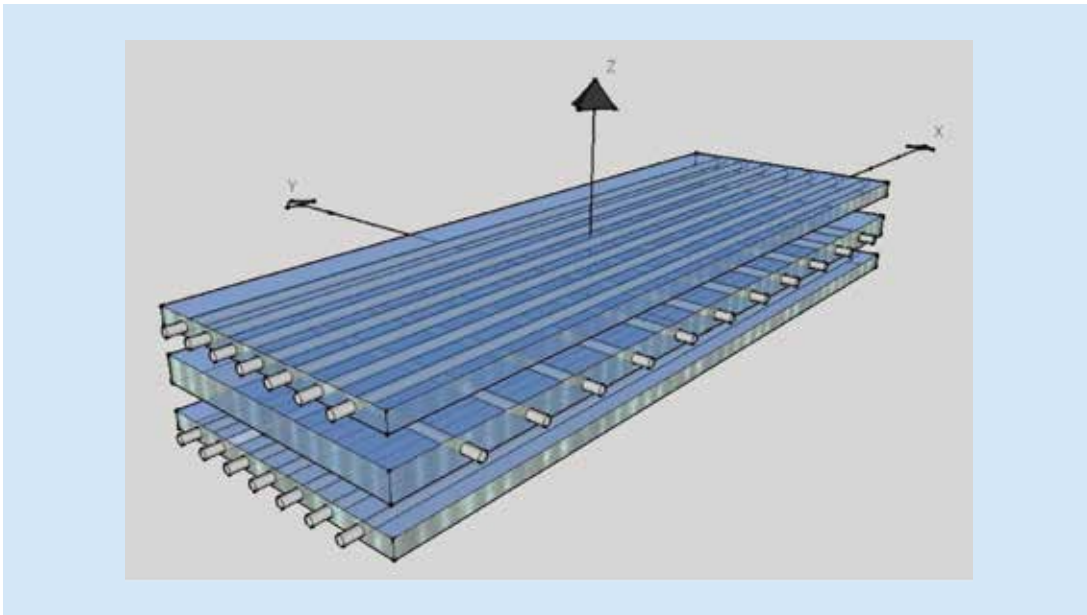

FIGURE J.2-1: Symmetric cross-ply [0/90/0] laminate

Typical laminates in civil engineering applications are symmetric, having a symmetric sequence of laminas about the mid-thickness of the laminate. In symmetrically stacked laminates with multiple specialty orthotropic layers, coupling between bending and twisting moments does not occur (Jones, 1997, Agarwal and Broutman, 1990) provided that the principal stresses are aligned with the x, y, or z direction. For example, a [0/90/0] laminate such as the one shown in Figure J.2-1 will have no bending-extension or bending-twisting coupling provided that the applied load is aligned with the principal x or y direction as shown. A balanced laminate, such as the one shown in Figure J.2-2 will contain pairs of layers with identical thickness and elastic properties but have $+\theta$ and $-\theta$ orientations of their principal material axes with respect to the laminate x, y, or z reference axis (Daniel and Ishai, 1994). It is noted here that certain designs, such as highly engineered FRP-composite airplane wings or helicopter blades, are designed to take advantage of coupling for certain desirable aeronautic features.

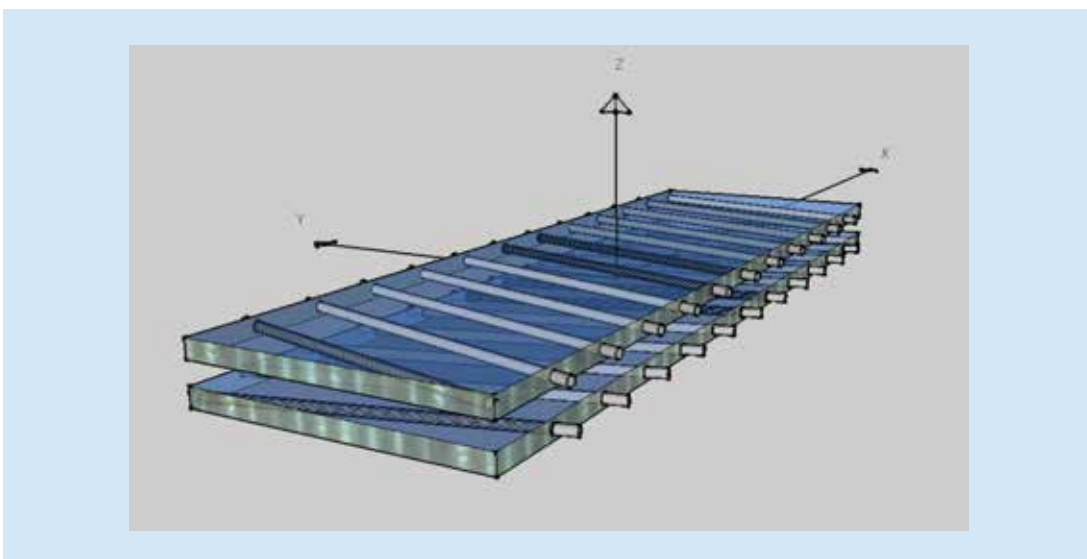

FIGURE J.2-2: Balanced [+45/-45] laminate

APPENDIX J ■ Engineering Design Guide

A unidirectional composite is characterized as having strength and stiffness in one direction, such as the x direction, far greater than in the other two. Such a composite is often termed unidirectionally reinforced with fibers or rovings along one preferred direction. Pultruded composite profiles such as tubes and angles are typically manufactured with continuous longitudinal rovings combined with continuous-filament mat (CFM) layers and an outer surface veil on each face. Despite the layers of randomly oriented fibers, the pultruded composite is termed unidirectional given the relative stiffness and strength along the continuous fiber direction as compared to the weaker CFM layers.

J.3 STRUCTURAL PROPERTIES OF FRP COMPOSITES

Once a composite is manufactured, the stiffness and strength of the global laminate is of primary concern unless stresses and strains in individual laminas, calculated by classical lamination theory (CLT) or higher order composite theories (HOCTs) (Jones, 1999), govern performance.

Algorithms designed to compute the laminate's modulus of elasticity in bending, twisting, tension, or compression are available. Many engineering software packages, such as finite-element-analysis (FEA) programs or supplier/manufacturer's spreadsheets, incorporate the equations found in CLT or HOCTs with an accurate knowledge of the individual fiber and resin properties of each lamina. Failure criteria such as maximum stress theory, maximum strain theory, maximum work theory, Tsai-Hill theory, Tsai-Wu theory (Agarwal and Broutman, 1990, Tsai, Wu 1971), as well as HOCTs are available to analyze individual laminate layers. Softwares are available which compare the internal stresses and strains within the lamina to these available failure theories. Independent structural testing of prototypes can verify predicted values to the strains and deflections measured from actual loading and support conditions. Typically, bending modulus values differ significantly from the tensile or compressive modulus due to the laminate stacking sequence and loading type.

Common values of tensile, flexural, and compressive strength and stiffness are given in Table J.3-1 below for various E-glass-fiber-laminate designs commonly used in architectural panels. Material properties can easily exceed those given in the Table for higher fiber volume contents, higher fiber strength and stiffness values such as those found for E-CR glass, differing manufacturing techniques, and different fiber architectures. For comparison, the mechanical properties of common carbon laminates are given in Table J.3-2.

APPENDIX J ■ Engineering Design Guide

TABLE J.3-1: Typical Properties of Various E-glass/General Purpose Orthophthalic Polyester Resin Laminates Considered for FRP Architectural Panels

Property	Orientation	Units	Type 1	Type 2	Type 3	Type 4	Type 5
			Laminate ^{1,2,A,B}	Laminate ^{1,2,3,4,A,B}	Laminate ^{1,9,10}	Laminate ^{1,9,11}	Laminate ^{1,9,12}
			1 ½ ounce CSM	1 ½ ounce CSM and 24 ounce WR	24 ounce 0°	36 ounce 0°/90°	24 ounce +45°/-45°
				Unidirectional	Stitched Biaxial	Stitched Biaxial	
Fiber content weight range	–	%	10–45	28–49	34–55	35–63	34–61
Tensile Strength ⁵	0°	ksi (MPa)	8.0–15 (55–103)	15–23 (103–159)	36–68 (248–469)	28–54 (193–372)	15–23 (103–159)
Tensile Strength ⁵	90°	ksi (MPa)	8.0–15 (55–103)	15–23 (103–159)	15–28 (103–193)	28–54 (193–372)	15–23 (103–159)
Tensile Modulus ⁵	0°	Msi (GPa)	0.7–1.3 (4.8–9.0)	1.1–1.8 (7.6–12.4)	2.20–4.14 (15.2–28.5)	1.73–3.28 (11.9–22.6)	0.92–1.39 (6.3–9.6)
Tensile Modulus ⁵	90°	Msi (GPa)	0.7–1.3 (4.8–9.0)	0.9–1.6 (6.2–11.0)	0.9–1.7 (6.2–11.7)	1.73–3.28 (11.9–22.6)	0.92–1.39 (6.3–9.6)
Flexural Strength ⁶	0°	ksi (MPa)	23–31 (159–214)	29–39 (200–269)	41–48 (283–331)	50–75 (345–517)	23–29 (159–200)
Flexural Strength ⁶	90°	ksi (MPa)	23–31 (159–214)	28–37 (193–255)	24–30 (165–207)	28–43 (193–296)	23–29 (159–200)
Flexural Modulus ⁶	0°	Msi (GPa)	0.6–1.2 (4.1–8.3)	1.0–1.7 (6.9–11.7)	1.6–1.9 (11.0–13.1)	1.93–2.89 (13.3–19.9)	0.88–1.13 (6.1–7.8)
Flexural Modulus ⁶	90°	Msi (GPa)	0.6–1.2 (4.1–8.3)	1.0–1.7 (6.9–11.7)	0.9–1.2 (6.2–8.3)	1.10–1.67 (7.6–11.5)	0.88–1.13 (6.1–7.8)
Compressive Strength ⁷	0°, 90°	ksi (MPa)	18–25 (124–172)	21–27 (145–186)	21–82 (145–565) ⁷	33–62 (228–427) ⁷	21–32 (145–221) ⁷
In-plane Shear Strength ⁸	0–90°	ksi (MPa)	10–12 (69–83)	10–12 (69–83)	12–18 (83–124)	11–20 (76–138)	13–24 (90–165)
In-plane Shear Modulus ⁸	0–90°	Msi (GPa)	0.27–0.51 (1.9–3.5)	0.28–0.52 (1.9–3.6)	0.39–0.55 (2.7–3.8)	0.35–0.60 (2.4–4.1)	0.70–1.25 (4.8–8.6)

Notes:

- A. *Reinforced Thermoset Plastic Corrosion-Resistant Equipment, ASME-RTP-1-2013*, American Society of Mechanical Engineers, 2013, New York, Table 2A-3, pg. 17.
- B. *Design Properties of Marine Grade Fiberglass Laminates*, Gibbs and Cox, Inc., 1973, USA, Figures 1-14, pp. 13-29.
 1. A corrosion-resistant outer surfacing veil is assumed, each face, 0.01 in. thickness per veil.
 2. CSM = Randomly oriented E-glass chopped strand mat, 1 ½ ounce/ft², 0.043 in. thick per ply.
 3. 0/90 degree (warp/fill) E-glass woven roving, 24 ounce/yd², 0.033 in. thick per ply.
 4. See *ASME-RTP-1-2013* for laminate stacking sequence of plies.
 5. Type 3, 4 and 5 laminate values obtained through vectorlam laminate analysis (Reference 9) based on an analysis of data obtained from applicable ASTM tests: ASTM D638 at 72°F, ASTM D3039 at 77°F, ASTM D5083 at 73°F; values valid up to 180°F.
 6. Type 3, 4 and 5 laminate values obtained through vectorlam laminate analysis (Reference 9) based on an analysis of data obtained from ASTM D790 tests at 73°F; values valid up to 180°F.
 7. Type 3, 4 and 5 laminate values obtained through vectorlam laminate analysis (Reference 9) based on an analysis of data obtained from applicable ASTM tests: ASTM D6641 at 73°F; ASTM D695 at 73°F; ASTM D3410 at 73°F.
 8. Type 3, 4 and 5 laminate values obtained through vectorlam laminate analysis (Reference 9) based on an analysis of data obtained from applicable ASTM tests: ASTM D3518 at 77°F; ASTM D5379 at 73°F; ASTM D4255 at 73°F; ASTM D7078 at 73°F.
 9. Values given based on a range of fiber volumes as a result of multiple manufacturing processes; laminate calculations obtained via lamination analysis, VectorLam software, provided by Vectorply Corporation; www.vectorply.com
 10. 0 degree (warp) E-glass to S2-glass unidirectional, 24 ounce/yd², 0.034 in. thick per ply.
 11. 0/90 degree (warp/fill) E-glass stitch-bonded biaxial, 36 ounce/yd², 0.051 in. thick per ply - data from a 2-ply (6-lamina) symmetric laminate [Veil/0/90/90/0/Veil].
 12. +45/-45 (double bias) E-glass stitch-bonded biaxial, 24 ounce/yd², 0.035 laminate [Veil/+45/-45/-45/+45/Veil].

APPENDIX J ■ Engineering Design Guide

TABLE J.3-2: Typical Properties of Standard Modulus Carbon/Epoxy Laminates

Property	Orientation	Units	Type 6	Type 7	Type 8	Type 9
			Laminate ^{1,9}	Laminate ^{2,9}	Laminate ^{3,9}	Laminate ^{4,9}
			Carbon 18 ounce 0° Unidirectional	Carbon 6 ounce Woven	Carbon 12 ounce 0°/90° Stitched Biaxial	Carbon 12 ounce +45°/-45° Stitched Biaxial
Fiber content weight range	—	%	45–64	40–63	45–64	45–64
Tensile Strength ⁵	0°	ksi (MPa)	132–200 (910–1380)	54–89 (372–614)	67–99 (462–683)	15–21 (103–145)
Tensile Strength ⁵	90°	ksi (MPa)	4.0–4.2 (28–29)	54–89 (372–614)	67–99 (462–683)	15–21 (103–145)
Tensile Modulus ⁵	0°	Msi (GPa)	11–17 (76–117)	5.37–8.87 (37–61)	6.06–8.97 (42–62)	1.48–2.09 (10–14)
Tensile Modulus ⁵	90°	Msi (GPa)	1.1–1.4 (7.6–9.7)	5.37–8.87 (37–61)	6.06–8.97 (42–62)	1.48–2.09 (10–14)
Flexural Strength ⁶	0°	ksi (MPa)	80–121 (552–834)	55–92 (379–634)	70–106 (483–731)	13–18 (90–124)
Flexural Strength ⁶	90°	ksi (MPa)	3.8–4.0 (26.2–27.6)	27–42 (186–290)	27–38 (186–262)	25–36 (172–248)
Flexural Modulus ⁶	0°	Msi (GPa)	10–16 (69–110)	8.18–13.72 (56.4–94.6)	9.63–14.47 (66.4–99.8)	1.27–1.78 (8.8–12.3)
Flexural Modulus ⁶	90°	Msi (GPa)	1.0–1.4 (6.9–9.7)	1.99–3.11 (13.7–21.4)	1.88–2.57 (13.0–17.7)	1.27–1.78 (8.8–12.3)
Compressive Strength ⁷	0°	ksi (MPa)	75–130 (517–896)	36–59 (248–407)	47–70 (324–483)	15–21 (103–145)
Compressive Strength ⁷	90°	ksi (MPa)	15–16 (103–110)	36–59 (248–407)	47–70 (324–483)	15–21 (103–145)
Compressive Modulus ⁷	0°	Msi (GPa)	11–17 (76–117)	5.37–8.87 (37–61)	6.06–8.97 (42–62)	1.48–2.09 (10–14)
Compressive Modulus ⁷	90°	Msi (GPa)	1.0–1.4 (6.9–9.7)	5.37–8.87 (37–61)	6.06–8.97 (42–62)	1.48–2.09 (10–14)
In-plane Shear Strength ⁸	0–90°	ksi (MPa)	7.5–7.9 (51.7–54.5)	7.4–7.8 (51.0–53.8)	8.4–11.9 (57.9–82.1)	45–68 (310–469)
In-plane Shear Modulus ⁸	0–90°	Msi (GPa)	0.42–0.59 (2.9–4.1)	0.39–0.58 (2.7–4.0)	0.42–0.59 (2.9–4.1)	2.76–4.11 (19.0–28.3)

Notes:

- 0 degree (warp) standard modulus carbon unidirectional, 18 ounce/yd², 0.029 in. thick per ply.
- 0/90 degree (warp/fill) carbon woven, 6 ounce/yd², 0.011 in. thick per ply - data from a 2-layer symmetric laminate.
- 0/90 degree (warp/fill) carbon stitch-bonded biaxial, 12 ounce/yd², 0.021 in. thick per ply - data from a 2-layer symmetric laminate [0/90/90/0].
- +45/-45 degree (double bias) E-glass stitch-bonded biaxial, 12 ounce/yd², 0.022 in. thick per ply - data from a 2-layer symmetric laminate [+45/-45/-45/+45].
- Laminate values obtained through vectorlam laminate analysis (reference 9) based on an analysis of data obtained from applicable ASTM tests: ASTM D638 at 72°F, ASTM D3039 at 77°F, ASTM D5083 at 73°F; values valid up to 180°F.
- Laminate values obtained through vectorlam laminate analysis (reference 9) based on an analysis of data obtained from ASTM D790 tests at 73°F; values valid up to 180°F.
- Laminate values obtained through vectorlam laminate analysis (reference 9) based on an analysis of data obtained from applicable ASTM tests: ASTM D6641 at 73°F; ASTM D695 at 73°F; ASTM D3410 at 73°F.
- Laminate values obtained through vectorlam laminate analysis (reference 9) based on an analysis of data obtained from applicable ASTM tests: ASTM D3518 at 77°F; ASTM D5379 at 73°F; ASTM D4255 at 73°F; ASTM D7078 at 73°F.
- Values given based on a range of fiber volumes as a result of multiple manufacturing processes; laminate calculations obtained via lamination analysis, VectorLam software, provided by Vectorply Corporation; www.vectorply.com.

APPENDIX J ■ Engineering Design Guide

Actual values of strength and stiffness can easily exceed those given in the tables due to the following:

- a. **Fiber type** – higher strength and stiffer fibers such as E-CR glass, and notably high modulus carbon fibers, will produce higher strength and stiffness values.
- b. **Fiber volume fraction** – the higher the weight fraction of fibers, W_f , the higher the strength and stiffness values of the laminate. Many engineering references cite a laminate's fiber volume, V_f , which can be found from ASTM testing (Ye, Svenson, Bank, 1995, McDonough et al 2004) and approximated knowing W_f and the material properties of the fiber, resin, and filler (RAE Technical Report 1988). In general, the more fiber layers within a given laminate thickness, the higher the W_f and V_f .
- c. **Fiber architecture** – laminates manufactured predominantly with continuous 0° degree fibers will produce higher strength and stiffness values along the direction of the fiber, but lower properties at 90° . Depending on manufacturing techniques and fiber volume fraction, fibers contained in a woven roving may produce higher or lower laminate strength and stiffness values than a laminate manufactured with individual 0° and 90° degree layers.
- d. **Manufacturing technique** – certain manufacturing techniques may result in a higher fiber- volume fraction, strength, or stiffness as a result of decreased laminate thickness and consistent fiber orientation.
- e. **Fillers** – the addition of fillers or additives to the resin may change strength and stiffness values.
- f. **Air voids** – the higher the amount of air voids in the manufactured laminate, the lower the strength and stiffness values.

Independent structural testing and analyses may indicate higher values than those shown above, while also incorporating actual boundary conditions such as those used in a bolted connection.

Further technical information related to strength is given below for engineering and design purposes.

J.4 TENSILE AND FLEXURAL STRENGTH

For most typical laminate configurations, the tensile strength and stiffness are mainly governed by the type of fiber, the orientation of the fiber to the applied tensile stress, and the relative volume of the fiber with respect to laminate (fiber volume). This is a direct result of the relative difference between fiber and resin strength and stiffness properties. For symmetric, balanced laminates, an increase in fiber strength, or amount (fiber volume), along the principal stress direction will increase the strength of the laminate in that specific direction. A designer should be aware, however, that such an increase may lower the strength and stiffness in other directions, such as the y and z direction in Figure J.2-1 for the benefit of the x direction. Thus all lamina strains and stresses should be analyzed. Strains as well as stresses and stiffness will not be uniform for anti-symmetric and/or unbalanced laminates despite a uniformly applied tensile load along a global x or y axis.

Flexural properties are dependent on the fiber type and highly dependent on the fiber orientation and lamina stacking sequence relative to the applied load or stress. As an example, the 0° degree fibers in Figure J.4-3 will carry the majority of tensile and compressive stresses given 1) the applied loading, 2) the fiber's location with respect to the z distance from the neutral axis, and 3) the actual direction of the fibers. This is predicted in CLT as well as HOCTs, and in classical beam theory if one simply considers items 1) and 2) for isotropic materials. For symmetric, balanced laminates the strain profile through the thickness will follow classical beam theory (CBT). However, the stress distribution profile will not follow CBT for an FRP laminate containing multiple, differing layers (Whitney, 1987). Strains as well as stresses and stiffness will not be uniform for anti-symmetric and/or unbalanced laminate despite a transverse load uniformly applied along a global x or y axis and coinciding with the shape's center of rotation.

APPENDIX J ■ Engineering Design Guide

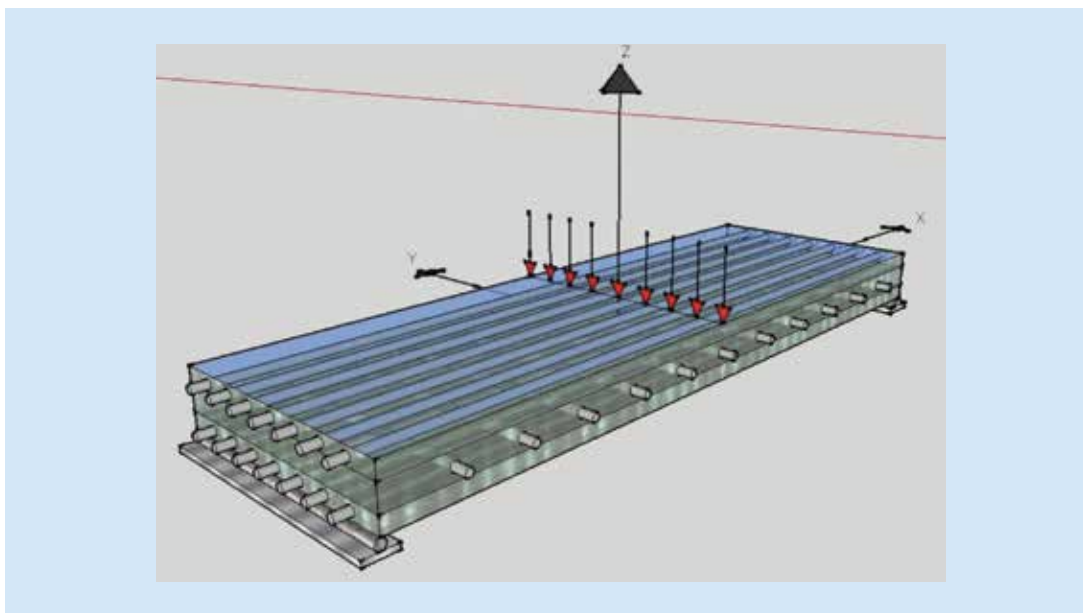

FIGURE J.4-3: [0/90/0] Laminate subjected to a transverse load

J.5 SHEAR STRENGTH

In-plane shear stresses are often calculated using CLT or approximated in FEA. References are available regarding internal shear-stress allowable values for individual layers within laminates for a given loading condition and part geometry. Mechanical testing ([See APPENDIX F: Test Methods](#)) is often used to verify such predictions. Often the in-plane shear modulus may govern failure modes such as compressive buckling (Steffen, 1998) or shear deflection in thick beams.

Through-thickness shear stresses can be characterized as translaminar – propagating through multiple layers, and may be of concern in thick composite components loaded out-of-plane. Through-thickness stresses rarely govern for the thin laminate skins found in most FRP architectural components, where thickness is an order of magnitude or more smaller than the width and length dimension. However, structural profiles with single, unidirectional rovings can experience shear cracking, which limits, for example, bolted connection design (Steffen, 1998). Calculations of out-of-plane shear stresses can be made from HOCTs.

As compared to intralaminar (in-plane) shear stresses, interlaminar shear stresses occur between individual layers within a laminate, and may cause edge delaminations (Jones, 1999) in highly loaded laminates with multiple layers. Interlaminar shear stresses are often found by noting the differences in stresses (tensile, compressive, or shear) between individual laminae within the laminate due to the applied loads. A typical process involves tabulating these stresses for each layer and looking for large variations between layers, then re-designing with new fiber architectures to reduce interlaminar shear stresses. Software packages such as finite-element-analysis programs or manufacturer’s spreadsheets incorporate the strain and stress equations found in CLT or HOCTs with an accurate knowledge of the individual fiber and resin properties of each lamina.

J.6 COMPRESSIVE STRENGTH

FRP laminates must resist applied compressive forces, and the FRP component must resist buckling due to the anticipated loads. Limited research is available regarding the compressive behavior of laminate designs considered for architectural panels. However, a discussion of the compressive behavior and analysis of pultruded FRP shapes can be found for short-term loadings (Zureick and Scott, 1997) and long-term loadings (Scott and Zureick, 1998).

APPENDIX J ■ Engineering Design Guide

J.7 BONDING PROPERTIES

When bonding to any substrate, the relative stiffness and strain to failure of the adhesive should be compared to that of the laminate within the range of operating temperatures anticipated. Environmental effects such as freeze-thaw cycles should be considered.

J.8 MOISTURE ABSORPTION

An FRP composite is often protected from moisture intrusion via a well-maintained exterior barrier such as a gelcoat or other durable surface coating, often combined with a surface veil material. However, if the exterior finish is compromised due to impact or other damage, or if an FRP designer does not limit the service stresses as compared to the laminate's ultimate values, long-standing moisture can affect the strength and stiffness of individual laminas, specifically the interface between the fiber and the "matrix" (resin) material. Repairs can be made to FRP laminates and coatings within impacted areas.

J.9 STIFFENERS

Discrete stiffeners may be attached to, or incorporated within, FRP laminates for a variety of reasons including deflection limitations, point load applications, or the necessity to stabilize a shape. These structural members, which are usually added to the backside of an FRP composite panel, may at times be used to connect the panels to their back-up structure. There are numerous ways of integrating stiffeners into composite panels. Figures J.9-1 and J.9-2 show stiffeners in flat and curved FRP components.



(Photo courtesy of Kreysler & Associates)

FIGURE J.9-1: Stiffeners placed within a flat FRP panel

APPENDIX J ■ Engineering Design Guide



(Photo courtesy of Kreysler & Associates)

FIGURE J.9-2: Stiffening ribs placed within a curved FRP structural member

J.10 CONNECTIONS

The bolted connection-bearing strength of an FRP composite material is highly related, but not limited, to all of the following:

- | | |
|--|--------------------------------|
| 1. Joint type, such as single versus double lap. | 4. Fiber type and orientation. |
| 2. Pin-loaded holes versus those with washers (bolts). | 5. Fastener material type. |
| 3. Pin size or bolt diameter size and torque. | 6. Edge and width ratios. |

In general, bearing strength increases as the torque is increased to a bolt within an FRP composite laminate (Hart-Smith, 1977). However, for FRP parts used as architectural systems, the design bearing strength often conservatively relies upon pin-bearing or finger-tight values, as the clamp-up force may diminish or vanish over time due to stress relaxation (EuroComp Design Code 2005). Additionally, the distance between the end of the material and the pin or bolt center, as well as the width between the bolt hole and free edge may need to increase as the bearing damage area reaches the end of the washer (Wang et. al. 1996, Cooper and Turvey 1995). Such distances are commonly referred to as e/d ratios and w/d ratios, and are substantially larger than similar ratios used for steel or aluminum. Typical details of lightly loaded FRP architectural components are found in [APPENDIX K: Typical Connections Details](#).

APPENDIX J ■ Engineering Design Guide

J.11 INSERTS AND EMBEDMENTS

The design of many FRP applications in commercial buildings, artwork, or architectural features often relies on inserted or embedded metallic rods, plates, or bent shapes. Two such common inserts are shown in Figures J.11-1 and J.11-2. Additional fibers and resin are placed along the insert to reduce stress concentrations and distribute forces over a large area. Additional inserts are found in [APPENDIX K: Typical Connection Detail](#).

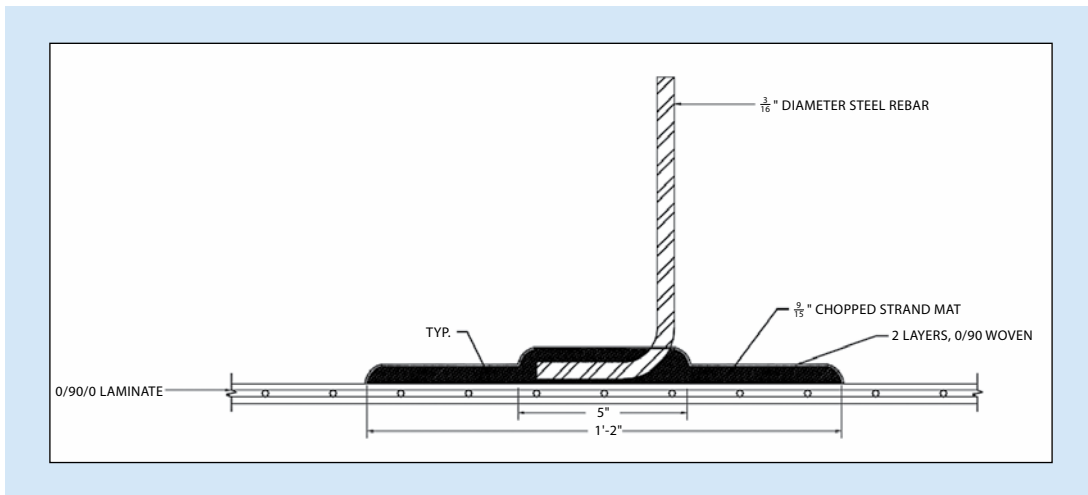

FIGURE J.11-1: Commonly used bent, threaded-rod connector

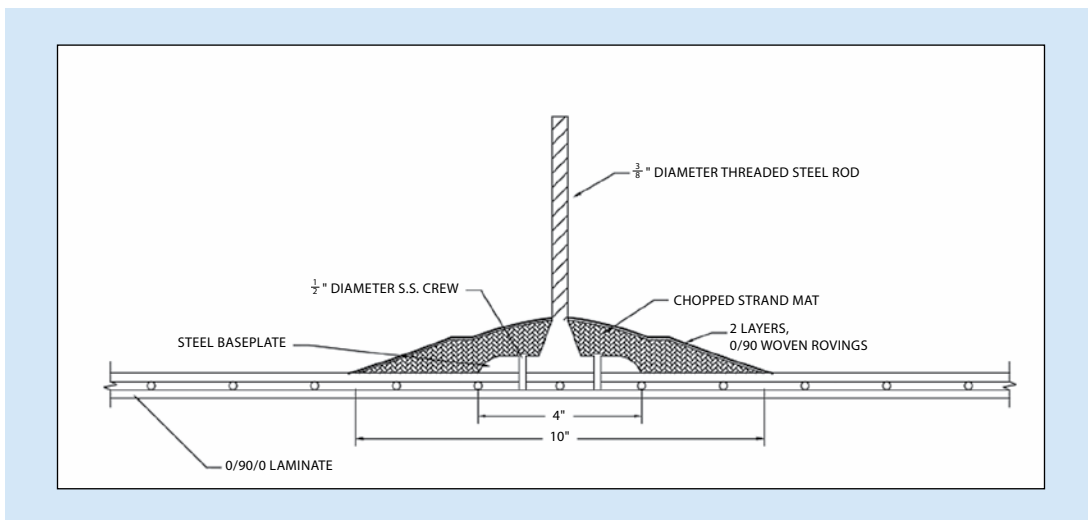

FIGURE J.11-2: Commonly used large, head-fastener connector

[RETURN TO TEXT: Design](#)

APPENDIX K

Typical Connection Details

APPENDIX K ■ Typical Connection Details

The connection illustrations below are presented as common details found in very lightweight FRP architectural components with panel or cornice face dimensions of 1 m² (10.8 ft²) or less. It is emphasized that the details should not be considered to have a load carrying capacity or load transfer path adequate for every particular project. Thus the exact details should not be used exclusively on a project without the project's engineer-of-record performing an analysis and giving specific approval.

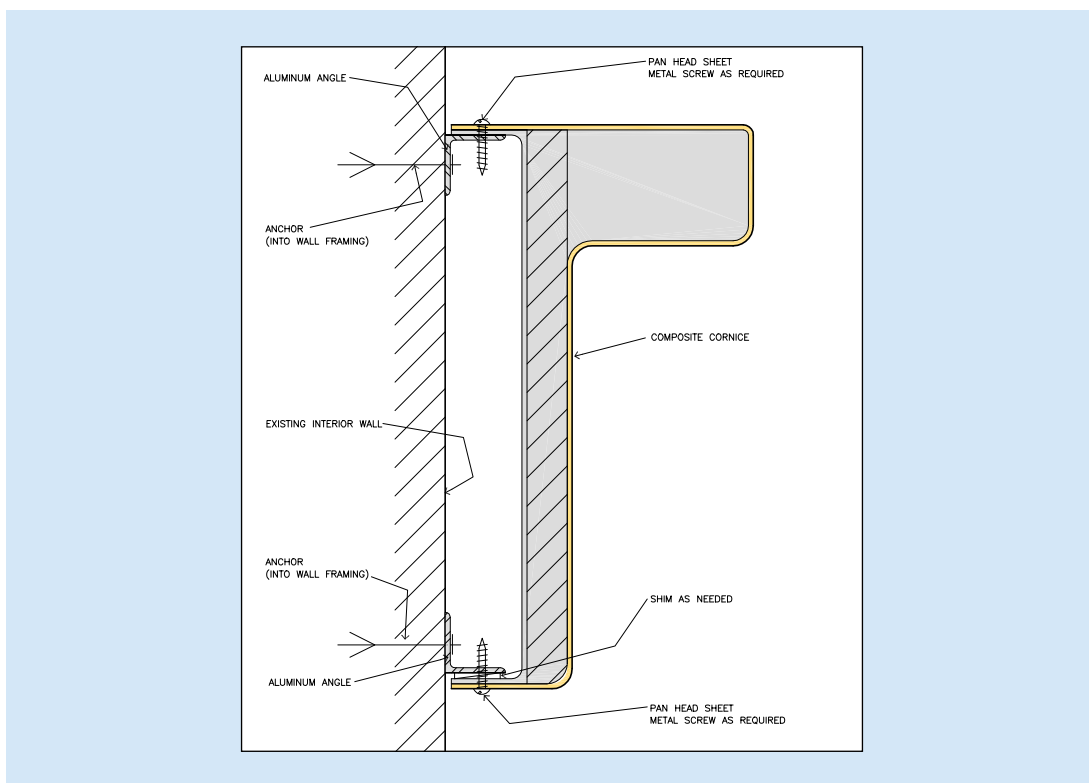

FIGURE K.1: Cornice connection cross section – Type A

APPENDIX K ■ Typical Connection Details

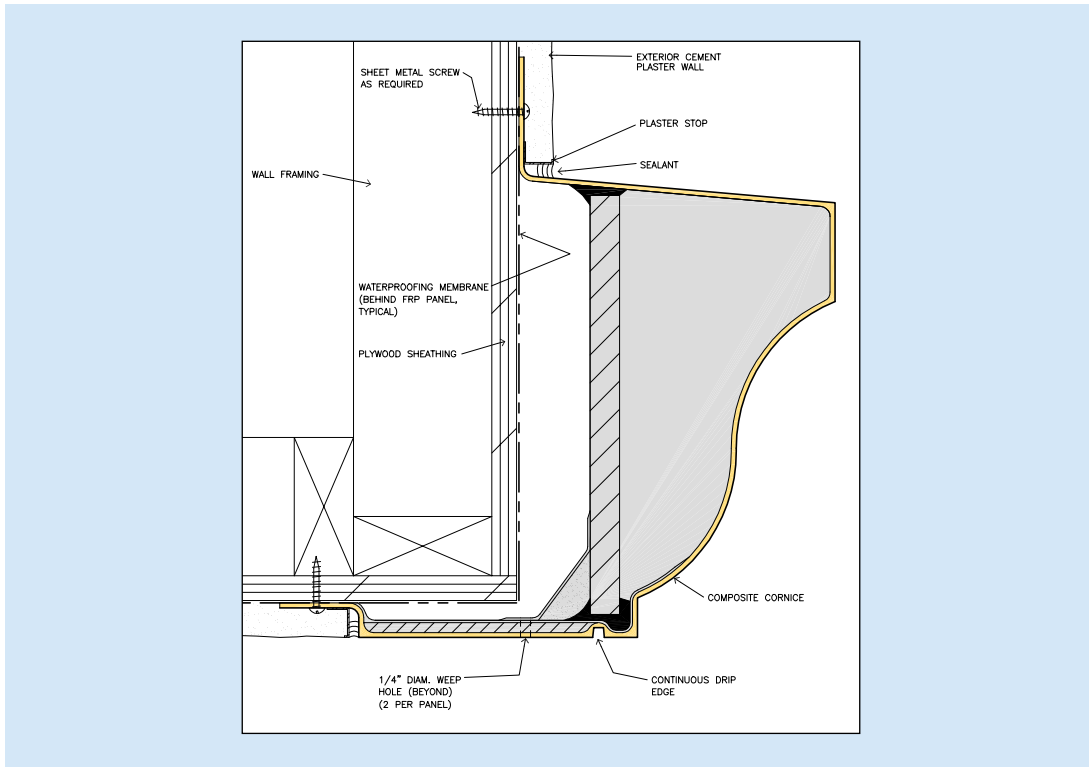

FIGURE K.2: Cornice connection cross section – Type B

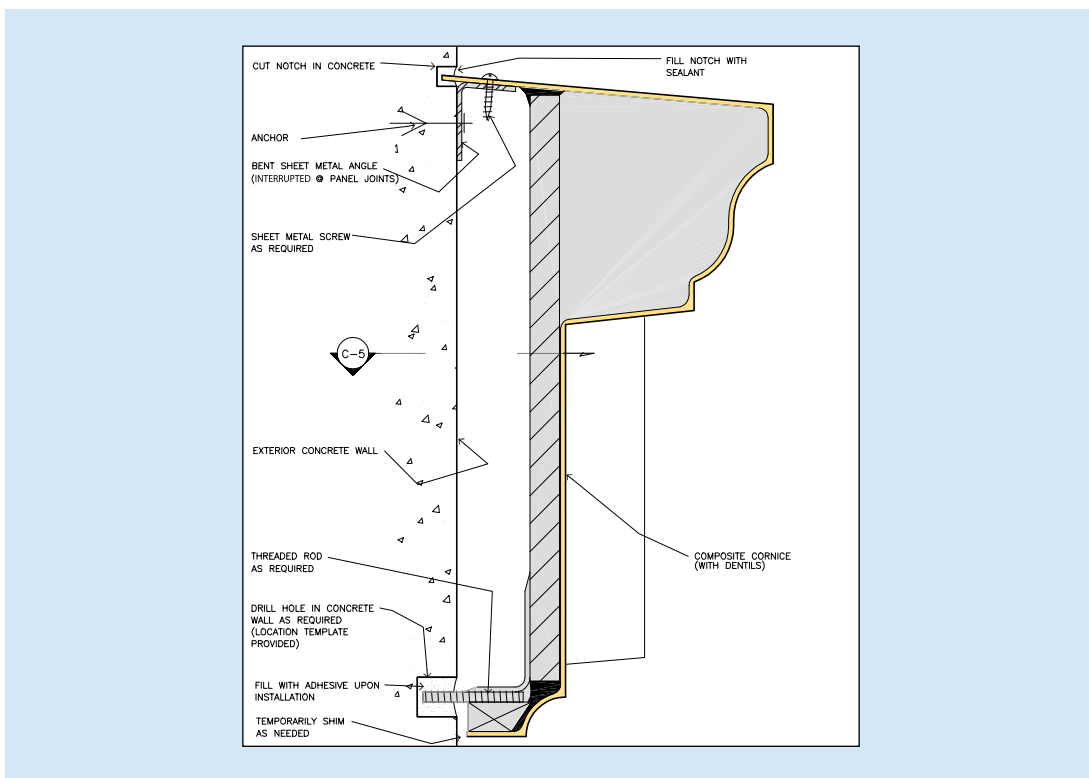

FIGURE K.3: Cornice connection cross section – Type C

APPENDIX K ■ Typical Connection Details

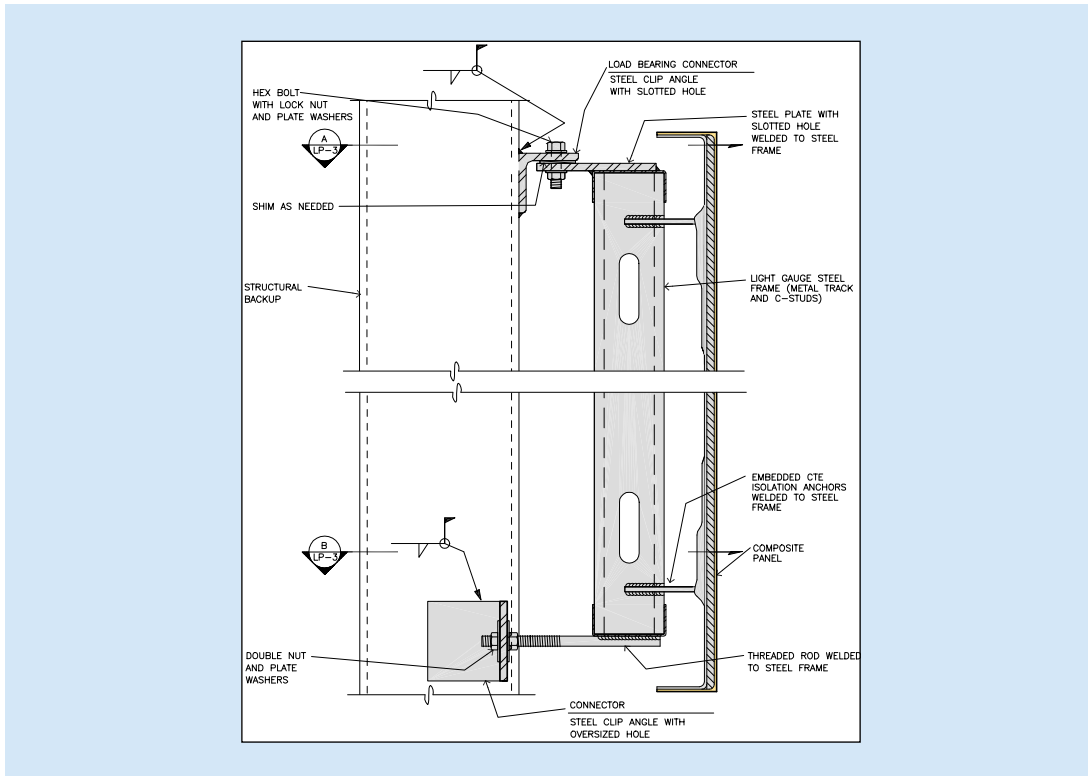

FIGURE K.4: Section view: FRP panels with steel frame support – Type 1

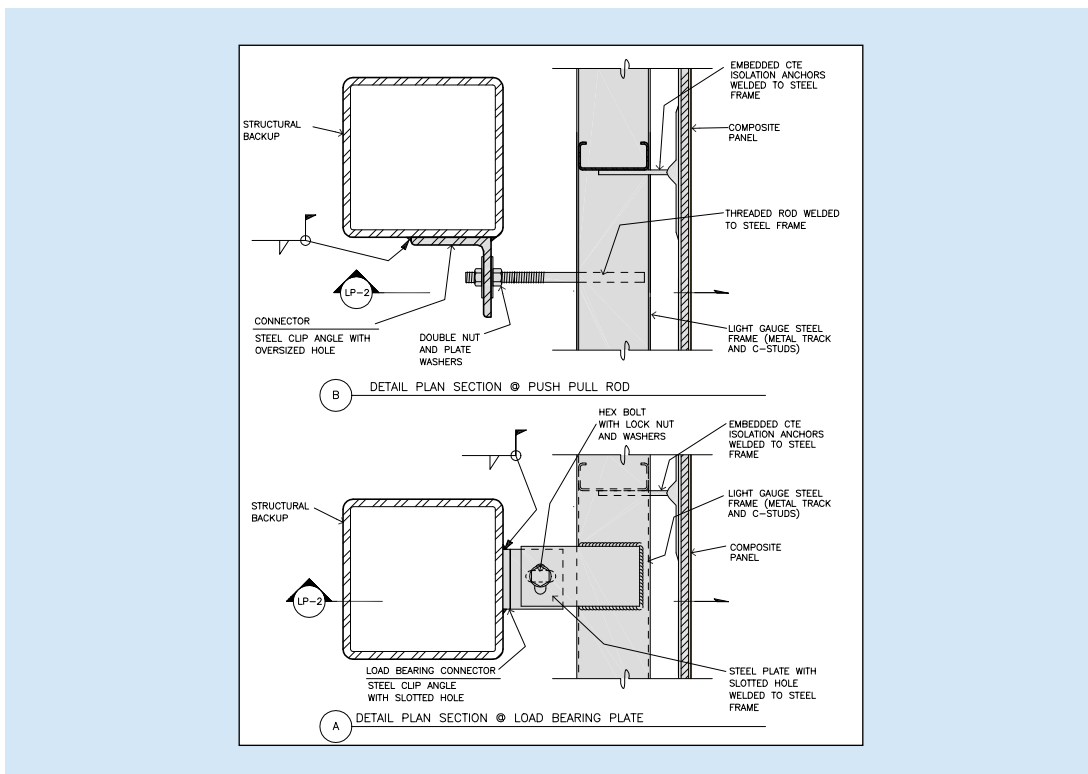

FIGURE K.5: Section view: FRP panels with steel frame support – Type 2

APPENDIX K ■ Typical Connection Details

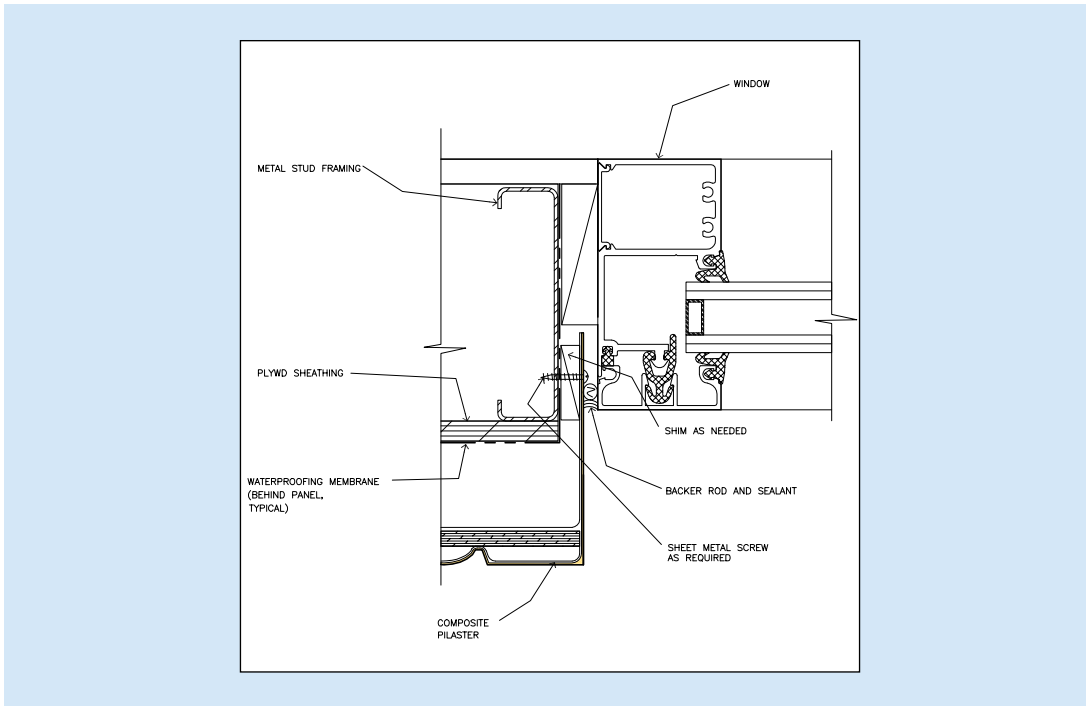

FIGURE K.6: Section view: FRP panels with steel support and window – Type 3

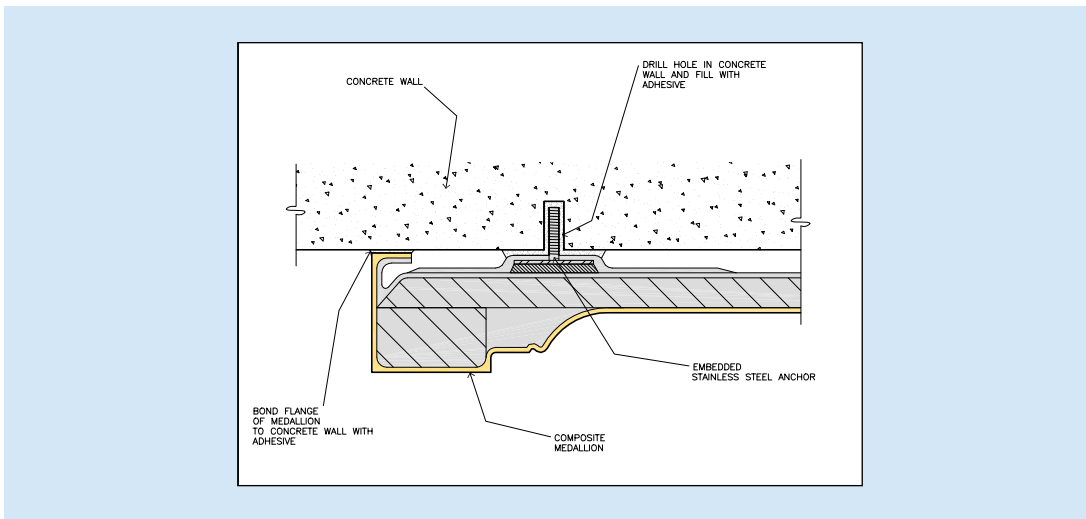

FIGURE K.7: Section view: Internal support FRP panels attached to concrete substrate

APPENDIX K ■ Typical Connection Details

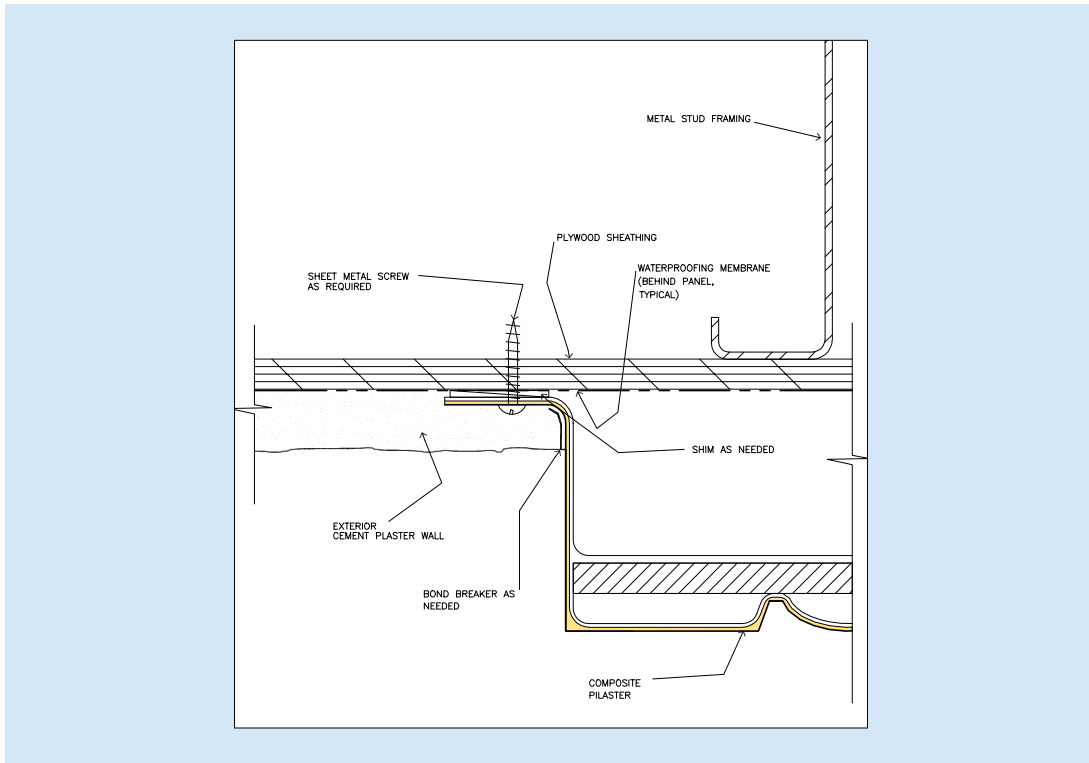

FIGURE K.8: Section view: Internal support FRP panels attached to wood substrate

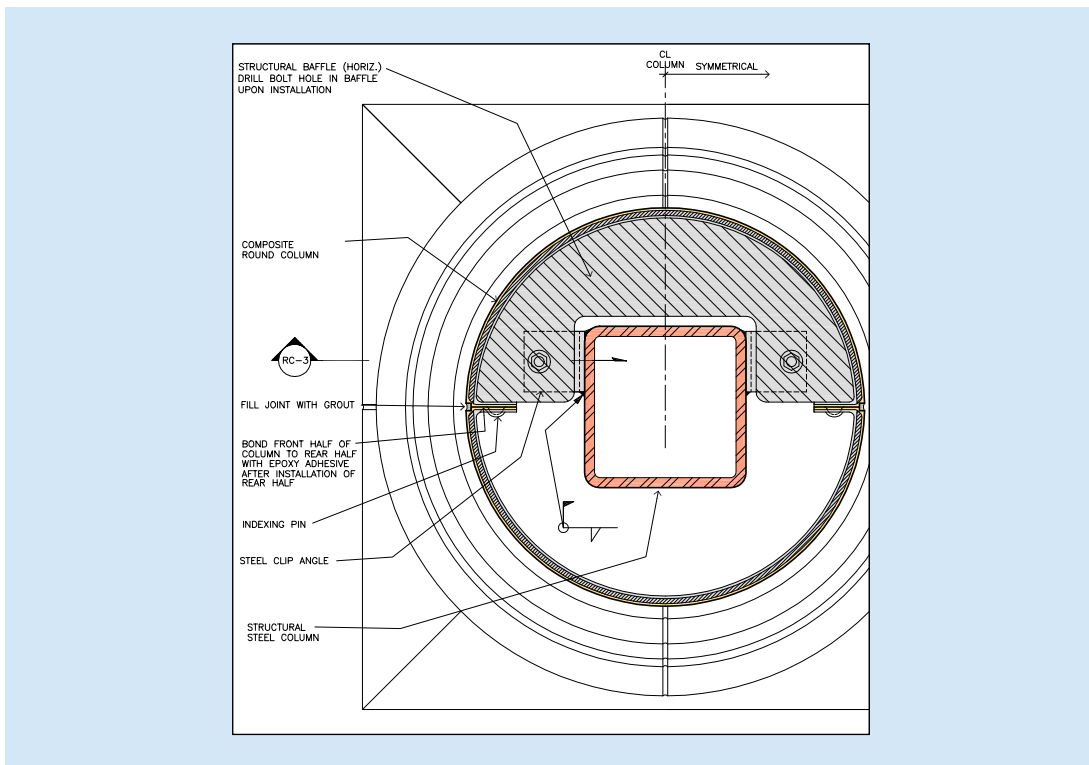

FIGURE K.9: Vertical section view: FRP attached to steel column

APPENDIX K ■ Typical Connection Details

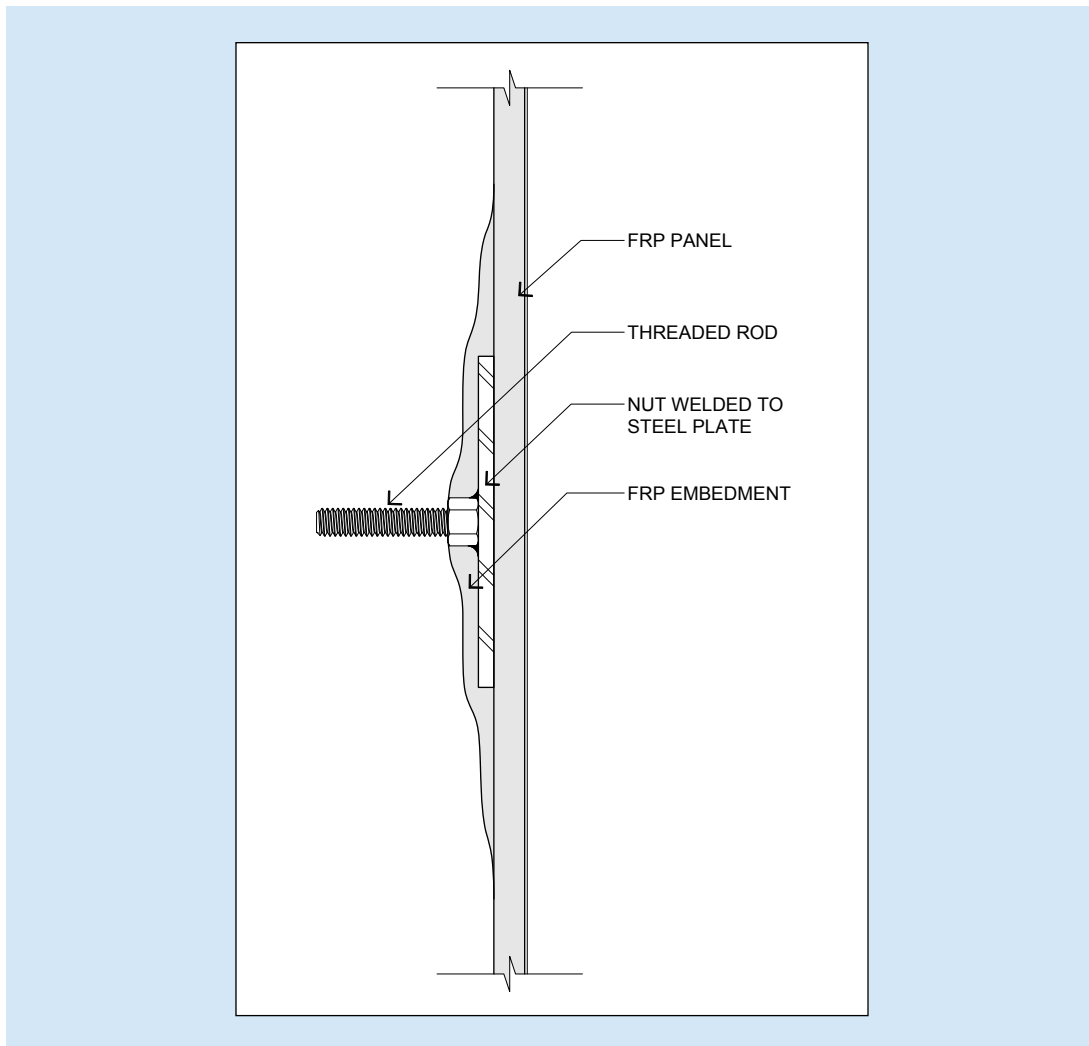

FIGURE K.10: Embedded nutplate connection

[RETURN TO TEXT: Design](#)

APPENDIX L

Design Example

APPENDIX L ■ Design Example

PROJECT:	Museum of Modern Art (MOMA), San Francisco
ARCHITECT:	Snohetta and EHDD
FRP CLADDING SUPPLIER:	Kreysler & Associates, Inc.
FRP ENGINEER-OF-RECORD:	Martin/Martin, Inc.



(photo courtesy of Snohetta/Jon McNeal)

FIGURE L.1: SFMOMA architectural rendering of FRP cladding

L.1 DEFINE ARCHITECTURAL REQUIREMENTS

SFMOMA project rendering is shown in Figure L.1.

- Geometry and form desired from designer.
- Aesthetic appearance.
- Fire-resistance and fire-rating requirements: ASTM E84 and ASTM E1354.
- Weather Exposure: The FRP cladding on the SFMOMA was primarily an architectural feature of the building. The weather enclosure system keeping moisture and air from entering the building was placed behind the FRP cladding and was considered a separate system attached to the FRP.

APPENDIX L ■ Design Example**L.2 DEFINE GEOMETRY OF BUILDING AND PANELS**

- Total Building Height: 110 ft.
- Plan Geometry: 360 ft. x 115 ft.
- Building Drift Requirements - In Plane and Out of Plane:
 - Building drift requirements are defined in ASCE 7 and depend on the type of lateral-load-resisting system as defined by the structural engineer of record and the controlling load case for the region. For this building, located in California, the drift requirements were defined by the seismic loads; and these are defined by ASCE 7 to be $0.015h_x * C_d$ for steel structures in Risk Category III.
- Define Building Support Points:
 - In this building, as is typical in buildings, the exterior cladding system spans vertically from floor to floor. The FRP cladding connects to the building enclosure system, which spans from concrete floor to concrete floor.

L.2.1 PANEL LOCATION IN PLAN AND ELEVATION:

The example panel is located on the East face and is centered roughly 25 ft. above the ground. In plan shown in Figure L.2, the panel sits on the center of the wall. This plan location defines the design wind zone.

APPENDIX L ■ Design Example

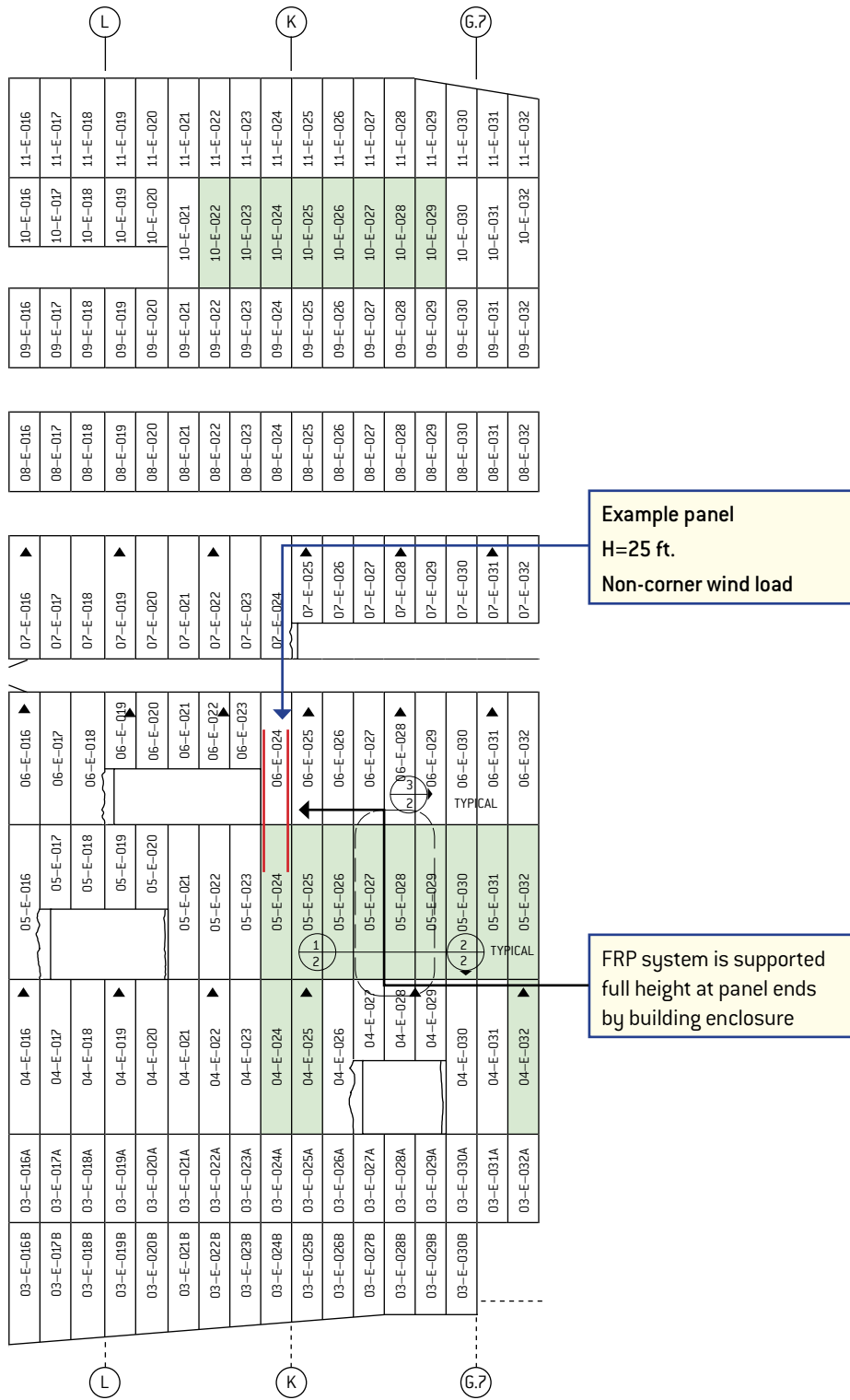

FIGURE L.2: Partial elevation view denoting FRP panel location, East elevation

APPENDIX L ■ Design Example

L.3 DEFINE STRUCTURAL DESIGN CRITERIA AND LOADS

- Risk Category: Risk Category III
- Deflection Criteria: FRP System Allowed to deflect L/60
- Wind Exposure: Exposure C
- Seismic Risk: Seismic Design Category D
- Dead Load: 6 psf dead load

Loads are calculated per ASCE 7. Seismic and wind loads must be accounted for per the code. Because the panels are so light, seismic loads did not control the design of the FRP component. Wind loads were the controlling load case. Calculated wind loads per ASCE 7 have been summarized in Table L.3-1 below:

TABLE L.3–1: Wind Loading Criteria Calculated per ASCE 7

Walls	GCp			Surface Pressure at “h”			User input	
Area	20 sf	100sf	500 sf	20 sf	100 sf	500 sf	10 sf	16 sf
Negative Zone 4	–0.90	–0.80	–0.70	–28.8 psf	–26.1 psf	–23.5 psf	–28.8 psf	–28.8 psf
Negative Zone 5	–1.80	–1.40	–1.00	–52.8 psf	–42.1 psf	–31.5 psf	–52.8 psf	–52.8 psf
Negative Zone 4 & 5	0.90	0.75	0.60	28.8 psf	24.8 psf	20.8 psf	28.8 psf	28.8 psf

NOTE: Negative zones 4 & 5 pressures apply to all heights. Positive pressures vary with height, see below.

L.4 DEFINE LOAD PATH AND SUPPORT STRUCTURE

Defining a simple and straightforward structural load path was crucial to the success of the project. An engineer and contractor were consulted early in the process and asked to define an efficient system that would be easy to build. The load path on the SFMOMA project was fairly simple. As shown in Figure L.3, each FRP component has steel J-bolts embedded in the panel. The steel J-bolts connect back to aluminum channels placed horizontally at roughly 3’0” on center. The aluminum channels span to vertical supports that connect to the moisture enclosure system. The entire panel and aluminum channels were fabricated in the shop and shipped to the site, streamlining the construction process.

APPENDIX L ■ Design Example

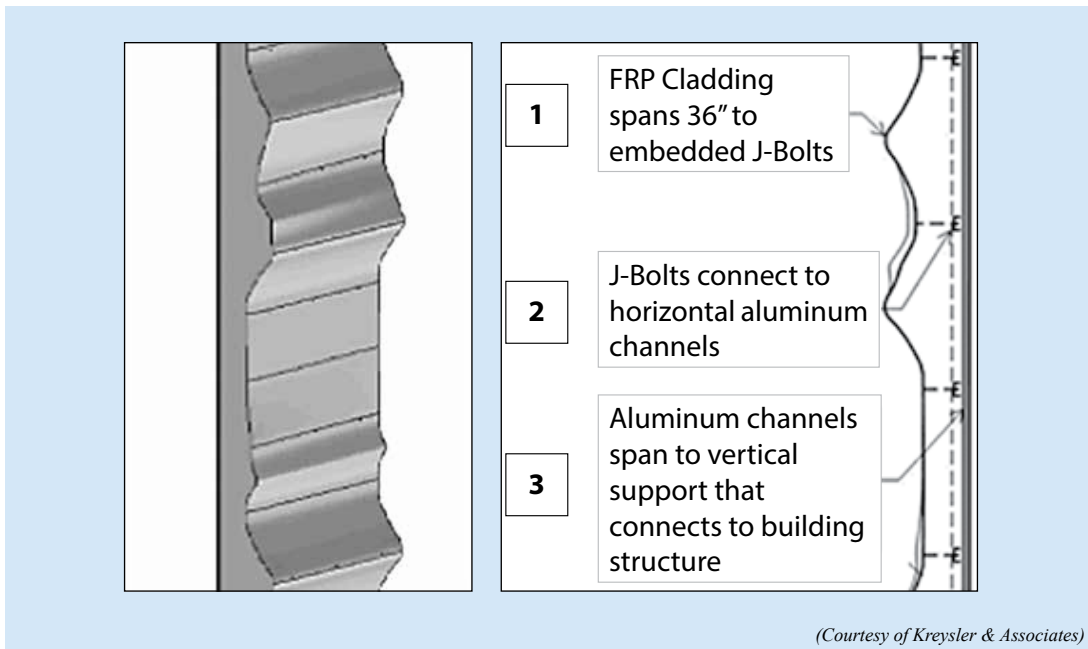

FIGURE L.3: Load path to aluminum supports

L.5 CALCULATE DEMAND AND DESIGN STRENGTH OF FRP COMPONENTS

Assemble load combinations for FRP components per IBC Chapter 6. Because this building resides in an area of high seismicity, ASCE 7 and IBC require the engineer to check both wind and seismic load cases. Below are the load combinations summarized from the ASCE 7 2005 Edition/IBC 2009.

- Dead + Wind
- 0.6 Dead + Wind
- Dead + 0.7 Earthquake
- 0.6 Dead + 0.7 Earthquake

Calculated stresses in the FRP material were compared to allowable material stresses. Stresses can be determined in a number of ways by any means of structural analysis. Finite element analysis tools were used to capture complicated behavior and distributions in this project as shown in Figure L.4. Deflection criteria were also checked.

APPENDIX L ■ Design Example

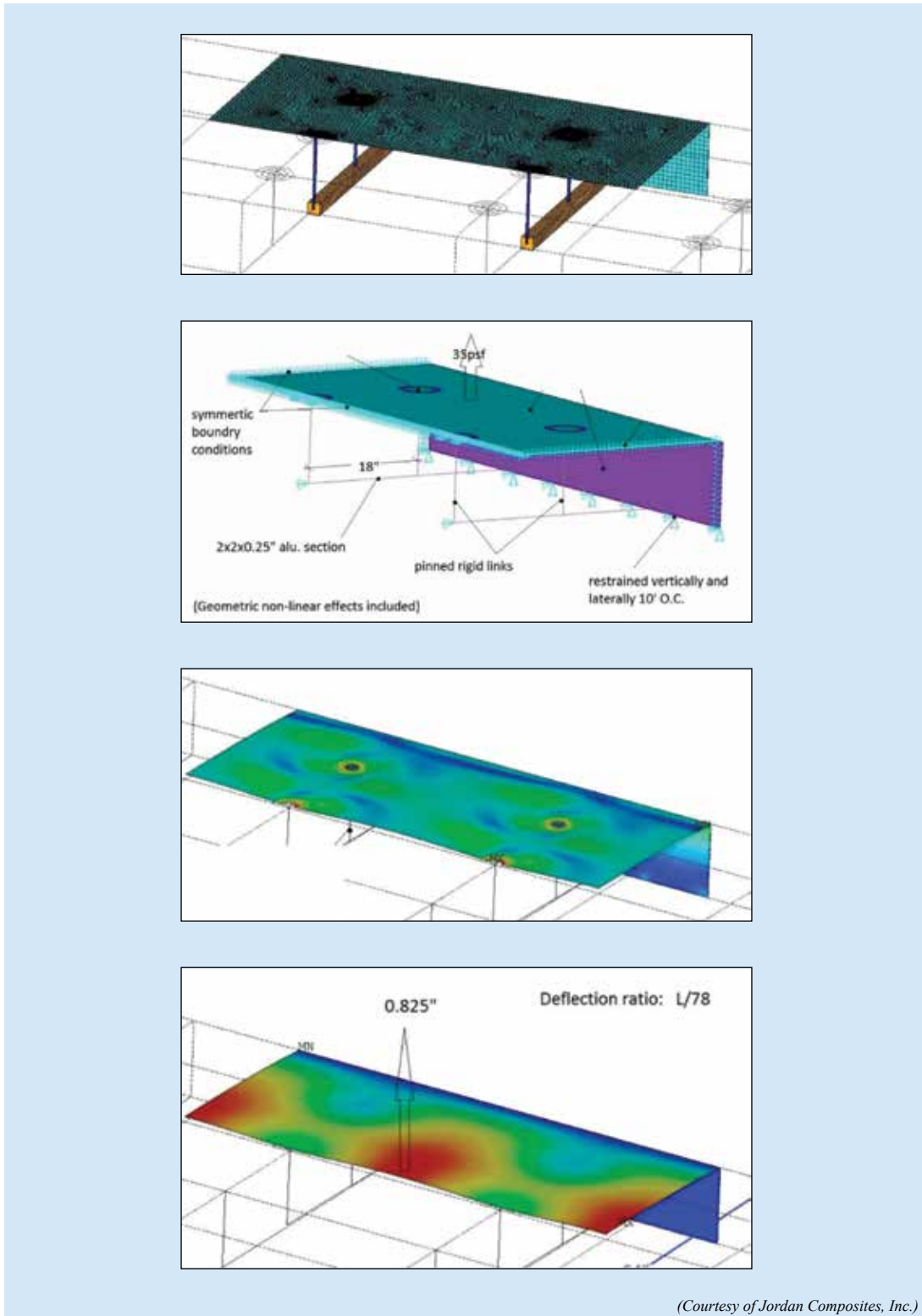

FIGURE L.4: Finite element analysis (FEA) screenshots

APPENDIX L ■ Design Example

L.6 CALCULATE DEMAND AND DESIGN STRENGTH FOR SUPPORT FRAME

Assemble load combinations for each FRP component per IBC Chapter 6. As stated earlier, this building resides in an area of high seismicity. Below are the load combinations summarized from the ASCE 7 2005 Edition/IBC 2009.

- Dead + Wind
- 0.6 Dead + Wind
- Dead + 0.7 Earthquake
- 0.6 Dead + 0.7 Earthquake

Perform testing on proposed connection or use an approved predefined connection. In the SFMOMA project, there were no predefined connections at the time. Tension and compression tests were performed to define the allowable strengths of the connections. Figures L.5 and L.6 show photos of the testing frame and experimental setup.

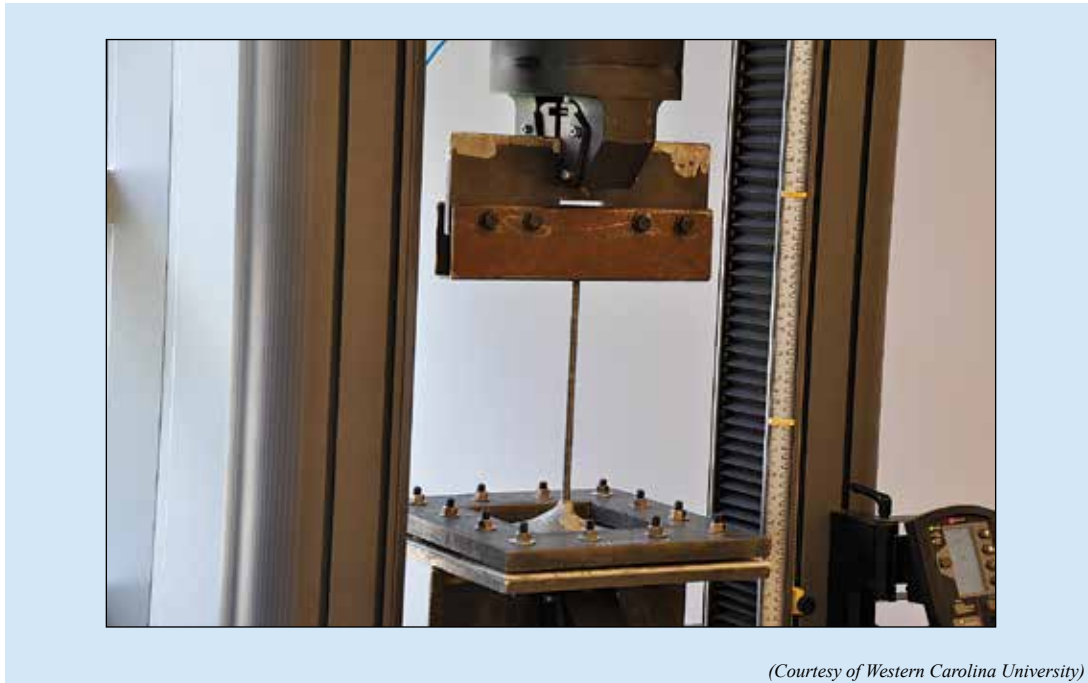

FIGURE L.5: Connection capacity testing – threaded steel rod to FRP laminate

APPENDIX L ■ Design Example



(Courtesy of Western Carolina University)

FIGURE L.6: Connection capacity testing – aluminum rod to FRP laminate

Calculate connection to support frame and compare to tested values. Figure L.7 shows an excerpt of the calculated strengths of the connections from the FRP cladding panel to aluminum channels.

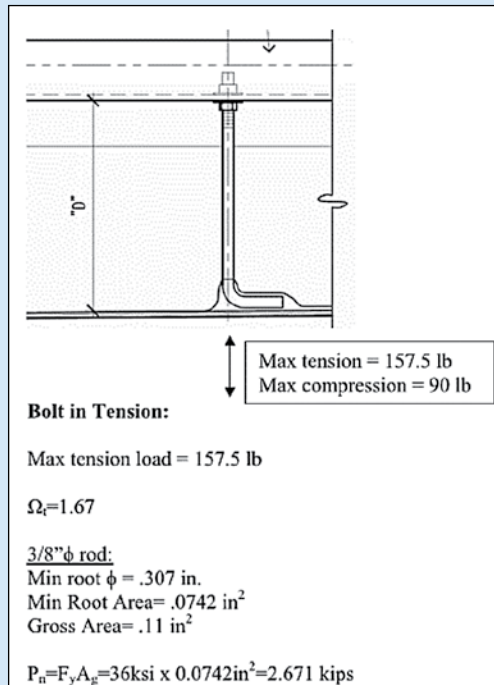

(Courtesy of Martin and Martin, Inc. Engineering)

FIGURE L.7: Calculation of connection components

APPENDIX L ■ Design Example

L.7 DEFINE GEOMETRY OF BUILDING AND LOCATION OF PANEL

Once again, assemble load combinations for the connection of the FRP assembly to building structure:

- Dead + Wind
- 0.6 Dead + Wind
- Dead + 0.7 Earthquake
- 0.6 Dead + 0.7 Earthquake

Calculate bolted assembly back to frame. At this point in the assembly, it is a simple aluminum-to-aluminum connection, which is well defined by building material codes. In the case of the SFMOMA, this is where the FRP cladding connects to the air/moisture enclosure system as shown in Figure L.8.

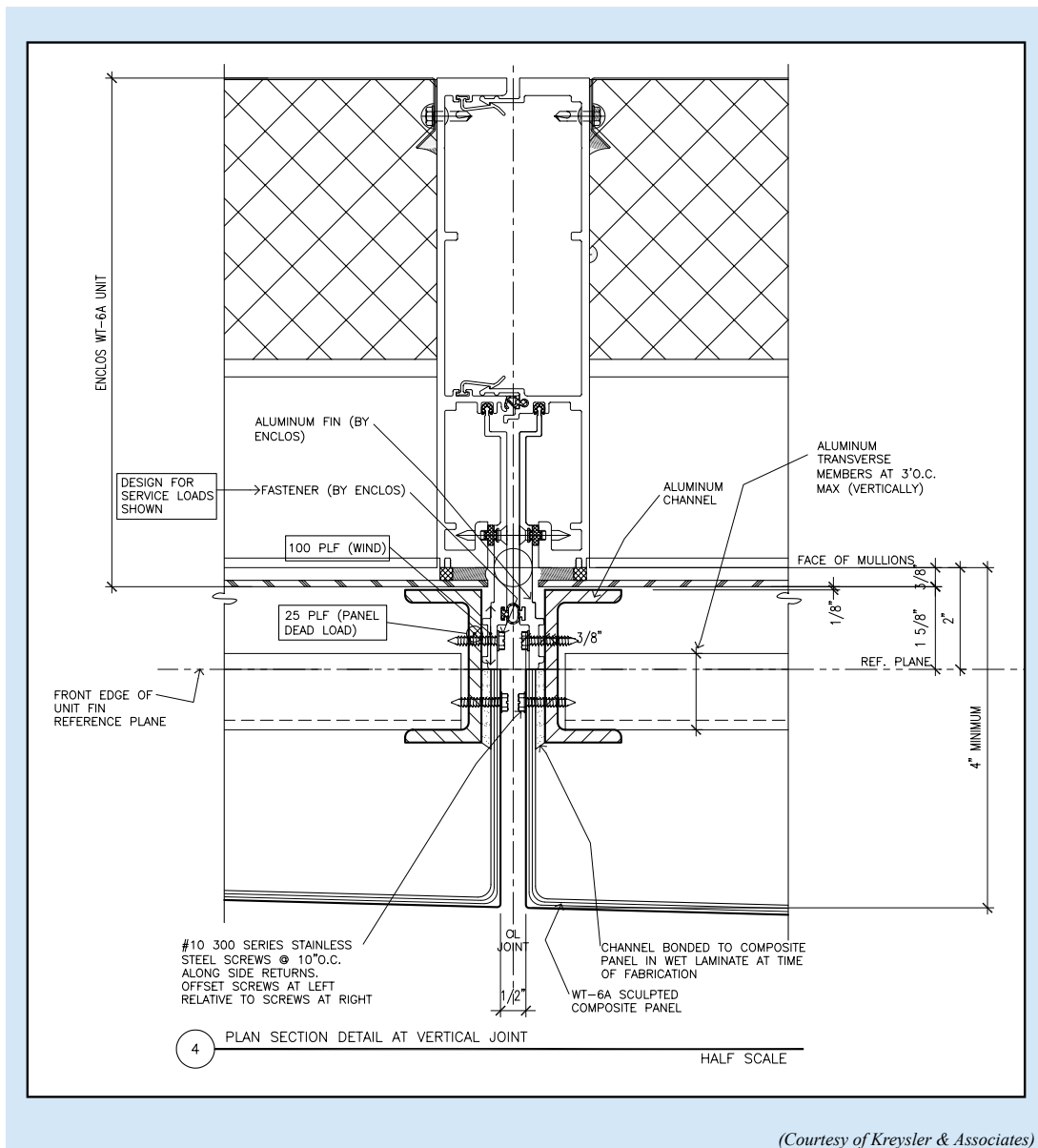

FIGURE L.8: FRP connection to aluminum backup

REFERENCES

REFERENCES

- 2015, 2012, 2009 International Building Code (IBC), International Code Council, Inc. Published in cooperation with Building Officials And Code Administrators International, Inc., Country Club Hills, Illinois.
- ANSI/ACMA/PIC Standard Practice (2011) Code of Standard Practice - Industry Guidelines For Fabrication And Installation of Pultruded FRP Structures, American Composites Manufacturers Association, 2011, Arlington, VA.
- ASME-RTP-1-2013 Reinforced Thermoset Plastic Corrosion-Resistant Equipment, The American Society of Mechanical Engineers (2013), New York, Table 2A-3, p. 17.
- CCP Cook Composites & Polymers (2005), Composites Applications Guide, 10 Edition, Cook Composites & Polymers Inc., Kansas City, Missouri.
- EUROCOMP Design Code and Handbook (2005), Structural Design of Polymer Composites, First Edition, Chapman & Hall, ISBN 0-203-78337-9, pp. 138-139.
- RAE Technical Report 88012 (1988), "Crag Test Methods for the Measurement of Engineering Properties of Fibre Reinforced Plastics", Royal AeroSpace Establishment, Edited by P.T. Curtis, Controller HMSO London, Part 10.
- Agarwal, B.D., Broutman, L.J. (1990), Analysis and Performance of Fiber Composites, Second Edition, John Wiley & Sons, p. 155.
- Cooper, C., Turvey, G.J. (1995), "Effect of Joint Geometry and Bolt Torque on the Structural Performance of Single Bolt Tension Joints in Pultruded GRP sheet Material", *Composite Structures*, Vol. 32, 1995, p. 223.
- Jones, R.M. (1999), Mechanics of Composite Materials, Second Edition, Taylor and Francis, p. 209
- Daniel, I. M., Ishai, O. (1994), Engineering Mechanics of Composites, Oxford University Press, Sections 5.7, 6.9, 6.14.
- Hancox, N.L. Mayer, R.M., (1994), Design Data for Reinforced Plastics, Chapman and Hall.
- Hart-Smith, L.J. (1977), "Bolted Joints in Graphite Epoxy Composites", National Aeronautics and Space Administration (NASA), NASA report No. CR-144899, Washington D.C.
- McDonough, W. G., Dunkers, J. P., Flynn, K. M. and Hunston, D. L., (2004), "A Test Method to Determine the Fiber and Void Contents of Carbon/Glass Hybrid Composites," *Journal of ASTM International* 1(3), pp. 1-15, March 2004.
- Sa, M.F., Gomes, A.M., Correia, J.R., Silvestre, N. (2011), "Creep Behavior of Pultruded GFRP elements-Part 1: Literature Review and Experimental Study", *Composite Structures* 93, pp. 2450–2459.
- Scott, David W., Zureick, Abdul-Hamid (1998), "Compression creep of a pultruded E-glass/vinylester composite", *Composites Science and Technology*, Volume 58, Issue 8, August 1998, pp. 1361–1369.
- Soden, P.D., Hinton, M.J., Kaddour, A.S. (1998), "Lamina properties, lay-up configurations and loading conditions for a range of fibre-reinforced composite laminates", *Composite Science and Technology*, Vol. 58, Issue 7.
- Steffen, R. (1998), Behavior and Design of Fiber-Reinforced Polymeric Composite Equal-Leg Single Angle Struts, Ph.D. thesis, Georgia Institute of Technology.
- Tsai, S.W., Wu, E.M. (1971), "A General Theory of Strength for Anisotropic Materials", *Journal of Composite Materials*, Vol. 5, p. 58.
- Wang, H., Hung, C., Chang, F. (1996), "Bearing Failure of Bolted Composite Joints. Part 1: Experimental Characterization", *Journal of Composite Materials*, Vol. 30, No. 12, pp. 1306-1307.
- Whitney, J.M. (1987), Structural Analysis of Laminated Anisotropic Plates, Technomic Publishing Company, p. 78.
- Wu, Z. Wang, X., Iwashita, K., Sasaki, T, Hamaguch, Y (2010), "Tensile fatigue behaviour of FRP and hybrid FRP sheets", *Composites: Part B* 41 (2010) pp. 396–402.
- Ye, B.S., Svenson, A.L., Bank, L.C. (1995), "Mass and volume fraction properties of pultruded glassfibre-reinforced composites", *Composites* Vol.26 (1995) pp. 725-731.
- Zureick, A. and Scott, D. (1997), "Short-Term Behavior and Design of Fiber-Reinforced Polymeric Slender Members under Axial Compression." *J. Compos. Constr.*, 1(4), pp. 140–149.



American Composites Manufacturers Association

3033 Wilson Blvd., Suite 420

Arlington, VA 22201

Phone: 703.525.0511 • Fax: 703.525.0743

www.acmanet.org