

POLYMER
COMPOSITE
COLUMNS



ARCHITECTURAL FIBERGLASS, INC.

8300 Bessemer Ave. * Cleveland, OH 44127-1839 * 216-641-8300 * Fax 216-641-8150 * www.fiberglass-afi.com

Centrifugal Spun Cast Fiberglass Reinforced Polymer (FRP) Composite Columns

Usually referred to as Polymer Composite Columns, they are manufactured as structural columns but can be used as column covers. They are hollow throughout which allows the columns to be factory split in halves to wrap structural posts. These columns are the most dense and heaviest of all the fiberglass materials. The column material thickness is from 1/4" to over 1" and is similar to concrete or cultured marble. The advantage of polymer columns is that they are very hard to the touch and solid sounding if knocked upon. Columns can be manufactured in standard sizes that range from 6" to 24" diameters. Heights range from 6' to 24'. They have load-bearing capacities from 6,000 to 20,000 pounds. Columns are tapered, straight, smooth or fluted, and can be manufactured with decorative capitals. Polymer Composite Columns are mass produced and the most economical and practical for smaller sized commodity type columns ranging from 6" diameter to 14" diameter and are still fairly manageable despite their heavy weight. Columns larger than 14" diameter may require additional manpower or lifting equipment. All Polymer Composite Columns need to be painted after installation and the design is limited only to the standard sizes listed in the tables on the following pages.

- Weatherproof
- Insect Free
- Low Maintenance
- Load-Bearing
- Architecturally Correct

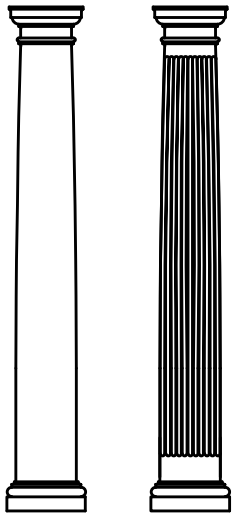

Smooth
Fluted
Round Tapered

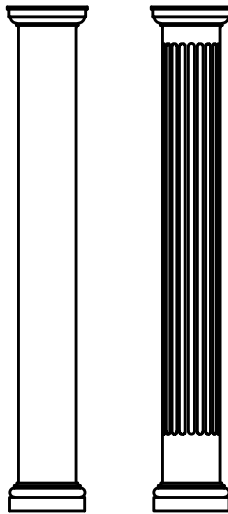

Smooth
Fluted
Round Non-Tapered

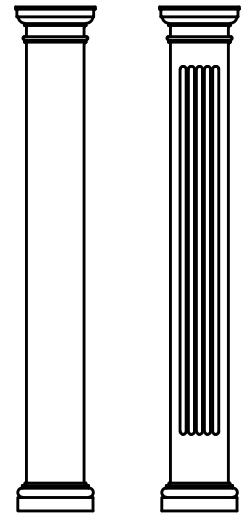

Smooth
Fluted
Square Non-Tapered

COLUMNS
SHEET NO.
PC-01
2020

POLYMER
COMPOSITE
COLUMNS



ARCHITECTURAL FIBERGLASS, INC.

8300 BESSEMER AVE., CLEVELAND, OHIO 44127-1839
(216) 641-8300 - FAX:(216) 641-8150
www.fiberglass-afi.com

Centrifugal Spun Cast Fiberglass Reinforced Polymer (FRP) Composite Columns

Round Tapered Columns

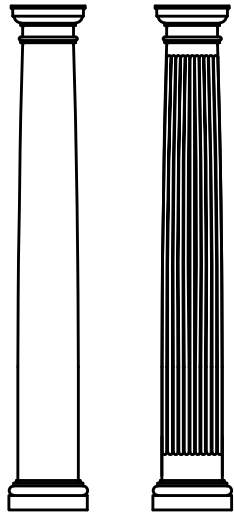

Nominal Shaft Diameter	Optional Attic Base						Total B-F
	Plinth		Torus				
	A	B	C	D	E	F	
6"	7 15/16	1					3 1/2
8"	10 7/8	1 7/8	1 1/8	7/8	3/4	1/2	5 1/8
10"	13 1/2	2 3/8	1 1/4	1 1/8	7/8	5/8	6 1/4
12"	16 1/8	2 3/4	1 1/2	1 3/8	1	5/8	7 1/4
14"	18 1/2	3 5/16	1 3/4	1 21/32	1 1/4	11/16	8 21/32
16"	21 3/16	3 3/4	2 7/32	1 7/8	1 15/32	13/16	10 1/8
18"	23 15/16	4 7/32	2 11/32	2 1/8	1 7/16	1 1/8	11 1/4
20"	27 1/16	4 3/4	2 11/16	2 3/8	1 3/4	1 7/16	13
24"	32 1/2	5 3/4	3 5/16	2 13/16	2 1/8	1 3/4	15 3/4

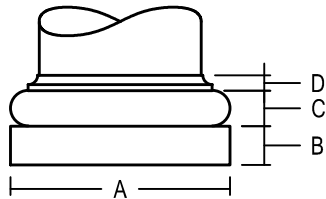

Tuscan Base

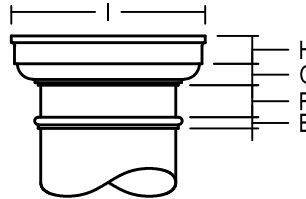

Tuscan Profile & Cap

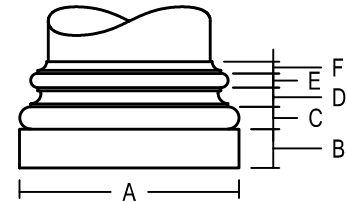

Optional Attic Base

Round Tapered Shaft			Tuscan Base					Shaft Profile		Tuscan Cap			
Outside Diameter*		Height	Plinth		Torus		Total B-D	Astragal		Echinus G	Abacus		Total G-H
Bottom	Top		A	B	C	D		E	F		H	I	
6"	4 3/4	5' - 8'	7 31/32	1 1/2	1 1/4	15/32	3 7/32	1/2	31/32	31/32	1 1/16	7 1/2	2 1/32
8"	6 1/2	5' - 10'	10 7/8	1 7/8	1 3/4	5/8	4 1/4	1/2	1 3/4	1 5/16	1 3/8	9 7/8	2 11/16
10"	8 1/2	4' - 12'	13 1/2	2 3/8	2 1/8	3/4	5 1/4	3/4	1 5/8	1 13/16	1 3/4	12 5/32	3 9/16
12"	10	5' - 16'	16 1/4	2 3/4	2 3/8	7/8	6	3/4	1 3/32	1 29/32	2	14 5/8	3 29/32
14"	12	6' - 20'	18 19/32	3 11/32	2 31/32	1	7 5/16	1	2 9/32	2 15/32	2 5/16	16 13/32	4 25/32
16"	13 1/2	5' - 20'	21 5/16	3 27/32	3 11/32	1 1/8	8 5/16	1	2 1/4	2 23/32	2 23/32	19 3/32	5 7/16
18"	15	8' - 24'	24 1/32	4 7/32	3 31/32	1 3/8	9 9/16	1	2 1/4	2 31/32	2 31/32	21 5/16	5 15/16
20"	17	6' - 24'	27	4 3/4	4 1/16	1 3/4	10 9/16	1 5/16	2 3/4	3 1/8	3 7/16	24 1/4	6 9/16
24"	20	8' - 24'	32 1/2	5 3/4	5 1/4	2 1/4	13 1/4	1 5/8	4 3/4	3 3/16	4 1/8	28 3/4	7 5/16

* Actual outside diameters are approximately 5/16" to 1/2" less than shown.
 + All columns available fluted.
 See PC-05 for load capacity and inside clearance

COLUMNS
 SHEET NO.
PC-02
 2020

POLYMER
 COMPOSITE
 COLUMNS



ARCHITECTURAL FIBERGLASS, INC.

8300 BESSEMER AVE., CLEVELAND, OHIO 44127-1839
 (216) 641-8300 - FAX:(216) 641-8150
 www.fiberglass-afi.com

Centrifugal Spun Cast Fiberglass Reinforced Polymer (FRP) Composite Columns

Round Non-Tapered Columns

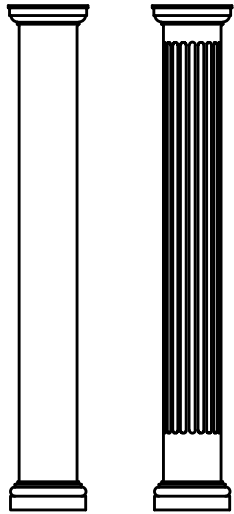

Nominal Shaft Diameter	Optional Attic Base						Total B-F
	Plinth		Torus				
	A	B	C	D	E	F	
6"	7 15/16	1					3 1/2
8"	10 7/8	1 7/8	1 1/8	7/8	3/4	1/2	5 1/8
10"	13 1/2	2 3/8	1 1/4	1 1/8	7/8	5/8	6 1/4
12"	16 1/8	2 3/4	1 1/2	1 3/8	1	5/8	7 1/4
14"	18 1/2	3 5/16	1 3/4	1 21/32	1 1/4	11/16	8 21/32
16"	21 3/16	3 3/4	2 7/32	1 7/8	1 15/32	13/16	10 1/8
18"	23 15/16	4 7/32	2 11/32	2 1/8	1 7/16	1 1/8	11 1/4
20"	27 1/16	4 3/4	2 11/16	2 3/8	1 3/4	1 7/16	13
24"	32 1/2	5 3/4	3 5/16	2 13/16	2 1/8	1 3/4	15 3/4

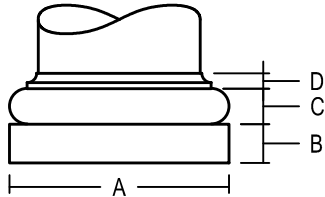

Tuscan Base

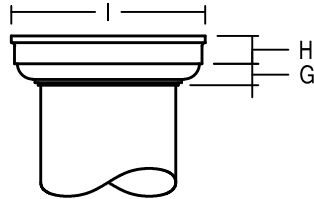

Tuscan Profile & Cap

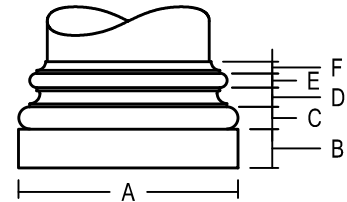

Optional Attic Base

Round Straight Shaft		Tuscan Base					Tuscan Cap			
Outside Diameter	Height	Plinth		Torus		Total	Echinus	Abacus		Total
		A	B	C	D	B-D	G	H	I	G-H
8"	8' - 10'	10 7/8	1 7/8	1 3/4	5/8	4 1/4	1 13/16	1 3/4	12 5/32	3 9/16
10"	8' - 10'	13 1/2	2 3/8	2 1/8	3/4	5 1/4	1 29/32	2	14 5/8	3 29/32
12"	8' - 12'	16 1/4	2 3/4	2 3/8	7/8	6	2 15/32	2 5/16	16 13/32	4 25/32
14"	8' - 14'	18 19/32	3 11/32	2 31/32	1	7 5/16	2 23/32	2 23/32	19 3/32	5 7/16
16"	8' - 10'	21 5/16	3 27/32	3 11/32	1 1/8	8 5/16	2 31/32	2 31/32	21 5/16	5 15/16
18"	8' - 11'	24 1/32	4 7/32	3 31/32	1 3/8	9 9/16	3 1/8	3 7/16	24 1/4	6 9/16
20"	8' - 11'	27	4 3/4	4 1/16	1 3/4	10 9/16	3 3/16	4 1/8	28 3/4	7 5/16
24"	8' - 15'	32 1/2	5 3/4	5 1/4	2 1/4	13 1/4	4 7/16	5 1/8	35 3/4	9 9/16

* Actual outside diameters are approximately 5/16" to 1/2" less than shown.
 + All columns available fluted.
 See PC-05 for load capacity and inside clearance

COLUMNS
 SHEET NO.
PC-03
 2020

POLYMER
 COMPOSITE
 COLUMNS



ARCHITECTURAL FIBERGLASS, INC.

8300 BESSEMER AVE., CLEVELAND, OHIO 44127-1839
 (216) 641-8300 - FAX:(216) 641-8150
 www.fiberglass-afi.com

Centrifugal Spun Cast Fiberglass Reinforced Polymer (FRP) Composite Columns

Square Non-Tapered Columns

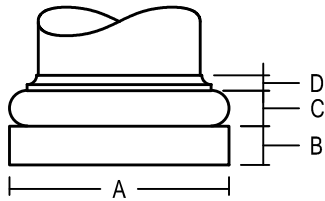
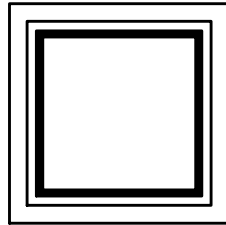

Tuscan Base

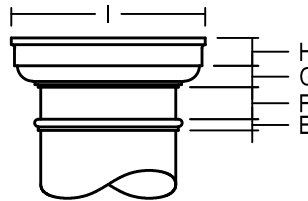

Tuscan Profile & Cap

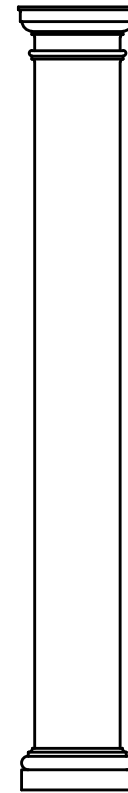

Smooth

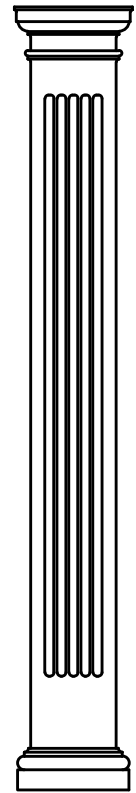

Fluted

Square Straight Shaft		Tuscan Base					Shaft Profile		Tuscan Cap			
Outside Width	Height	Plinth		Torus		Total	Astragal		Echinus	Abacus		Total
		A	B	C	D	B-D	E	F	G	H	I	G-H
6"	8' - 10'	8	1 1/2	1 1/4	15/32	3 7/32	3/4	1	31/32	1 1/16	8 7/16	2 1/32
8"	8' - 10'	10 7/8	1 7/8	1 3/4	5/8	4 1/4	3/4	1 3/4	1 3/4	1 3/8	11 1/4	2 11/16
10"	8' - 12'	13 1/2	2 3/8	2 1/8	3/4	5 1/4	3/4	1 9/16	1 13/16	1 3/4	13 7/32	3 9/16
12"	8' - 16'	17	2 3/4	2 3/8	7/8	6	3/4	1 1/8	1 7/8	2	17 1/4	3 7/8
14"	8' - 16'	18 13/16	3 3/8	2 15/16	1 1/16	7 3/8	1	2 3/16	2 15/32	2 11/32	18 11/16	4/1316

* Actual outside widths are approximately 1/8" less than shown.
 + All columns available fluted.
 See PC-05 for load capacity and inside clearance

COLUMNS
 SHEET NO.
PC-04
 2020

POLYMER
 COMPOSITE
 COLUMNS



ARCHITECTURAL FIBERGLASS, INC.

8300 BESSEMER AVE., CLEVELAND, OHIO 44127-1839
 (216) 641-8300 - FAX:(216) 641-8150
 www.fiberglass-afi.com

Centrifugal Spun Cast Fiberglass Reinforced Polymer (FRP) Composite Columns Round Tapered Columns

NOMINAL SHAFT DIAMETER	LOAD CAPACITY		INSIDE CLEARANCE		TOP VIEW LOADING DEFINITIONS Concentric Loading Eccentric Loading	
	CONCENTRIC LOAD	ECCENTRIC LOAD	INSIDE ROUND	INSIDE SQUARE		
6"	6,000	6,000	3 1/2"	2 1/2"		
8"	10,000	6,600	5"	3 1/2"		
10"	14,000	10,720	7"	4 15/16"		
12"	18,000	13,200	8 3/4"	6"		
14"	20,000	11,520	9"	6 3/8"		
16"	20,000	13,200	10 1/2"	7 7/16"		
18"	20,000	9,040	11 3/4"	8 5/16"		
20"	20,000	18,960	13 7/8"	10"		
24"	20,000	13,200	17"	12 3/16"		

Centrifugal Spun Cast Fiberglass Reinforced Polymer (FRP) Composite Columns Round Non-Tapered Columns

NOMINAL SHAFT DIAMETER	LOAD CAPACITY		INSIDE CLEARANCE		TOP VIEW LOADING DEFINITIONS Concentric Loading Eccentric Loading	
	CONCENTRIC LOAD	ECCENTRIC LOAD	INSIDE ROUND	INSIDE SQUARE		
8"	10,000	8,240	6 3/8"	4 1/2"		
10"	14,000	11,520	8"	5 5/8"		
12"	18,000	11,520	10 3/8"	7 5/16"		
14"	20,000	18,120	11 1/8"	7 7/8"		
16"	20,000	13,200	13"	9 3/16"		
18"	20,000	9,040	14 1/2"	10 1/4"		
20"	20,000	18,960	16 1/2"	11 5/8"		
24"	20,000	13,200	19 1/2"	13 3/4"		

Centrifugal Spun Cast Fiberglass Reinforced Polymer (FRP) Composite Columns Square Non-Tapered Columns

NOMINAL SHAFT WIDTH	LOAD CAPACITY		INSIDE CLEARANCE		LOADING DEFINITIONS (top view)	
	CONCENTRIC LOAD	ECCENTRIC LOAD	INSIDE ROUND	INSIDE SQUARE		
6"	6,000	6,000	4 1/2"	4 1/2"		
8"	10,000	10,000	5 1/2"	5 1/2"		
10"	14,000	12,380	8 1/2"	8 1/2"		
12"	18,000	17,320	10 1/2"	10 1/2"		
14"	20,000	17,320	12 1/2"	12 1/2"		

COLUMNS
SHEET NO.
PC-05
2020

POLYMER
COMPOSITE
COLUMNS



ARCHITECTURAL FIBERGLASS, INC.

8300 BESSEMER AVE., CLEVELAND, OHIO 44127-1839
(216) 641-8300 - FAX:(216) 641-8150
www.fiberglass-afi.com

COLUMN INSTALLATION INSTRUCTIONS

1. MEASURE THE EXACT FLOOR TO CEILING HEIGHT USING A PLUMB TO INSURE ACCURACY.
2. CUT THE BOTTOM OF THE COLUMN SHAFT AS NEEDED TO ACHIEVE THE MEASUREMENT TAKEN IN STEP 1. USE AN ABRASIVE BLADE. CAUTION: BECAUSE ONLY THE SHAFT IS LOAD BEARING, ITS TOP AND BOTTOM EDGES MUST BE LEVEL TO ACHIEVE FULL, EVEN CONTACT BETWEEN LOAD SURFACES AND SHAFT. USE A RASP TO LEVEL AS REQUIRED. NOTE: ALL HEIGHT ADJUSTMENTS MUST BE MADE FROM THE BOTTOM OF THE SHAFT. FOR THE CAP TO FIT CORRECTLY, THE TOP OF THE SHAFT MUST BE TRIMMED ONLY ENOUGH TO ACHIEVE LEVEL CONTACT WITH LOAD SURFACES, OR TO ACHIEVE CORRECT INSTALLATION OF DECORATIVE CAPITALS.
3. SLIP ONE-PIECE CAP AND BASE ONTO COLUMN SHAFT (SEE FIGURE 1). THE TWO-PIECE CAP AND BASE ARE ATTACHED AFTER THE SHAFT IS INSTALLED. IF THIS COLUMN IS INSTALLED WHERE IT COULD COLLECT WATER OR DEBRIS, THE TOP OF THE COLUMN AND CAP MUST BE FLASHED (COVERED) TO PREVENT SUCH COLLECTION. USE LEAD, COPPER, ALUMINUM, GALVANIZED, ETC. FLASHING CUT SLIGHTLY LARGER THAN THE CAP, AND FOLD THE EDGES DOWN OVER THE CAP AFTER STEP 5. IT IS NOT PERMISSIBLE AT ANY TIME TO FILL THE INTERIOR OF THE COLUMN SHAFT WITH SAND, CONCRETE OR ANY OTHER MATERIAL.
4. IF INSTALLATION REQUIRES SOME METHOD OF SECURING THE COLUMN IN PLACE BEFORE LOAD IS APPLIED, AN L-BRACKET WITH NUTS AND BOLTS (SEE FIGURE 2) NOTE: ALWAYS DRILL CLEARANCE HOLES IN COLUMNS AND SECURE WITH THROUGH-BOLTS -- DO NOT USE SCREWS -- AND DO NOT OVER-TIGHTEN.
5. APPLY STANDARD CONSTRUCTION ADHESIVE TO FLASHING (IF USED), TOP SURFACE OF CAP AND BOTTOM SURFACE OF BASE; THEN TIP LOOSELY ASSEMBLED COLUMN SHAFT INTO POSITION, ALIGN FLASHING (IF USED), AND LOWER LOAD ONTO SHAFT TO HOLD IT IN POSITION. ALIGN SQUARE PART OF CAP WITH LOAD SURFACE (OR FLASHING) ABOVE AND PUSH UP AGAINST IT TO SECURE. ALIGN SQUARE PART OF BASE WITH LOAD SURFACE BELOW CAP AND PUSH DOWN UNTIL IT IS SECURE.
6. CAULK GAPS BETWEEN SHAFT AND CAP AND BASE AS DESIRED.
7. ALL ROUND COLUMNS ARE FACTORY SANDED. ALL SURFACES OF CAP AND BASE, SQUARE COLUMNS, AND THE CONCAVE AREA AT THE BOTTOM OF THE FLUTES ON FLUTED COLUMNS REQUIRE PREPARATION BY SANDING WITH 80 TO 100 GRIT SANDPAPER. SAND TO REMOVE ALL GLOSSY AREAS. ALWAYS FOLLOW THE INSTRUCTIONS OF THE PAINT MANUFACTURER.
 - A. TO PAINT WITH OIL BASE PAINT, REMOVE ALL DUST AND DIRT BY THOROUGHLY WIPING COLUMN WITH CLEANER COMPATIBLE WITH YOUR CHOSEN PAINT. ALLOW TO DRY COMPLETELY. USE A HIGH QUALITY OIL BASE PAINT. PRIMER IS NOT NEEDED IF THE OIL BASE PAINT IS THE DESIRED COLOR.
 - B. TO PAINT WITH ACRYLIC LATEX PAINT, WE RECOMMEND USING A HIGH QUALITY PRIMER LIKE SHERWIN-WILLIAMS® PREPRITE® ANCHOR-BOND AND A TOPCOAT LIKE SHERWIN-WILLIAMS® SUPERPAINT®. REMOVE ALL DUST AND DIRT BEFORE PAINTING BY THOROUGHLY CLEANING WITH A CLEANER LIKE SIMPLE GREEN® OR ISOPROPYL ALCOHOL. ALLOW TO DRY COMPLETELY BEFORE PRIMING.

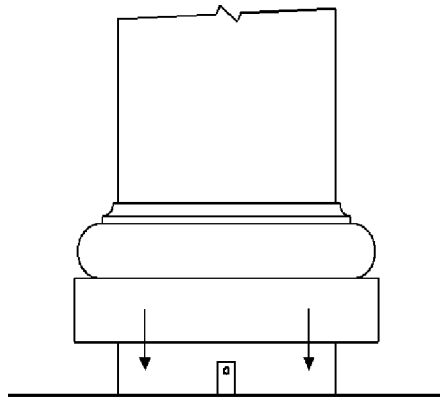

Figure 1

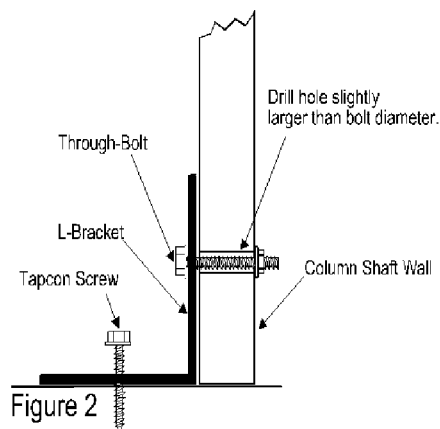

Figure 2

SPLIT COLUMN INSTALLATION INSTRUCTIONS

1. COLUMNS MAY BE FACTORY SPLIT TO COVER LALLY COLUMNS, POSTS, ETC. OR FIELD SPLIT USING AN ABRASIVE CARBORUNDUM OR CARBIDE BLADE. NOTE: SPLIT COLUMNS ARE NOT LOAD BEARING, EVEN WHEN REASSEMBLED.
2. TO REJOIN HALVES APPLY A GOOD QUALITY CONSTRUCTION ADHESIVE TO ALL JOINT SURFACES. PLACE THE COLUMN HALVES AROUND THE EXISTING SUPPORT COLUMN. CAREFULLY ALIGN THE TWO HALVES TOGETHER. LOOSELY INSTALL RATCHET OR NYLON STRAPS AROUND THE ASSEMBLED COLUMN APPROXIMATELY 2 TO 3 FEET APART. INSERT 1/8" SPACERS OR SHIMS INTO EACH JOINT OF THE COLUMN AND THEN PULL THE STRAPS TIGHT. AFTER ALL STRAPS AND SPACERS HAVE BEEN INSTALLED, POSITION THE COLUMN AND SECURE THE L-BRACKETS TO THE TOP AND BOTTOM SURFACES.
3. WHEN CONSTRUCTION ADHESIVE CURES USE POLYESTER BODY FILLER (BONDO OR DURAGLAS) TO FILL THE JOINT. FOLLOW THE BODY FILLER MANUFACTURER'S MIXING RECOMMENDATIONS. WORK THE BODY FILLER INTO THE JOINTS WITH A PLASTIC BODY FILLER SPREADER OR PUTTY KNIFE.
4. WIPE OR SCRAPE AWAY ANY EXCESS BODY FILLER. AFTER THE BODY FILLER HAS CURED, REMOVE THE STRAPS AND REMOVE THE SPACERS. FILL THE AREAS OF THE JOINTS WHERE THE SPACERS AND STRAPS HAD BEEN WITH BODY FILLER.
5. AFTER ALL OF THE BODY FILLER HAS CURED, SAND THE JOINTS SMOOTH WITH SANDPAPER. IF NECESSARY, FILL ANY LOW SPOTS WITH BODY FILLER. SAND AGAIN UNTIL SMOOTH.
6. APPLY CONSTRUCTION ADHESIVE TO THE TOP OF THE CAP. PUSH THE CAP UP AGAINST THE CEILING SURFACE BEING CAREFUL TO ALIGN THE SQUARE PORTION OF THE CAP TO THE SURFACE. APPLY CONSTRUCTION ADHESIVE TO THE BOTTOM OF THE BASE. PUSH THE BASE DOWN AGAINST THE FLOOR SURFACE BEING CAREFUL TO ALIGN THE SQUARE PORTION OF THE BASE TO THE SURFACE.
7. CAULK THE JOINT BETWEEN THE CAP AND THE COLUMN SHAFT AND THE JOINT BETWEEN THE BASE AND THE SHAFT. FINISH COLUMNS AS INDICATED ABOVE.

COLUMNS

SHEET NO.

PC-06

2020

POLYMER
COMPOSITE
COLUMNS



ARCHITECTURAL FIBERGLASS, INC.

8300 BESSEMER AVE., CLEVELAND, OHIO 44127-1839
(216) 641-8300 - FAX:(216) 641-8150
www.fiberglass-afi.com